

SOUND DEVICES



Kashmir™
MICROPHONE PREAMPS

MixPre II Series

Multichannel Recorders | Mixers | USB Audio Interfaces

User Guide v9.01

Table of Contents

Welcome to the MixPre II	3
Customize With Plugins	3
Panel Views	4
Powering the MixPre II	13
Power Switchover and Priority	13
Touchscreen	14
Transport Controls	16
Navigating Menus	17
Front Panel Locks	18
Choosing Your Mode	19
Custom Mode	22
Channel Screen - Basic Mode	22
Channel Screen - Advanced Mode	24
Linking Channels	26
Inputs Menu	27
Metering	29
Limiters	30
Outputs	31
Headphone Out	33
Tone	34
Slate Mic (MixPre-10 only)	34
Using the MixPre II as a USB Audio Interface	35
USB Output Routing	36
System	37
Formatting Media	38
Record - Basic Mode	39
Record - Advanced Mode	40
File Splits	41
Timecode	41
Timecode Modes	42
Presets	43
Projects	43
File List - Basic Mode	44
File List - Advanced Mode	45
Cue Marks	46
Using Star Shortcuts (*/**)	48
Wingman Application	49
USB Hub	53
USB Keyboard	54
X-Keys® Programmable Keypads, Sticks & Keyboards	55
USB Controllers	56
Akai MidiMix Interface Functions	58
Korg NanoKontrol 2 Interface Functions	59
Korg NanoKontrol Studio Interface Functions	60
Novation LaunchControl XL Interface Functions	61
Mounting to a Camera or Tripod	62
MixPre-3 II Specifications	64
MixPre-6 II Specifications	66
MixPre-10 II Specifications	68
Warranty	70

Software License	71
Limited Warranty	72
Legal Notices	72

Welcome to the MixPre II

Versatile. Durable. High-Performance.

If you record field audio, sound effects, audio for film, podcasts, voice-overs, music, or are just starting your audio journey, the MixPre II Series is for you! Lightweight, durable, and small, this powerhouse audio recorder and USB interface will help you capture audio for any application. Three models are available: MixPre-3 II* (3 channels, 5 tracks); MixPre-6 II (6 channels, 8 tracks); MixPre-10 II (10 channels, 12 tracks). *The MixPre-3 II can be expanded to 5 channels, 7 tracks with the optional +2ch plugin.

With Sound Devices' hand-crafted, crystal-clear, ultra low-noise Kashmir preamps, you'll record audio in superior quality - all the way up to a 32-bit float bit depth and a 192 kHz sample rate. This newest generation of Sound Devices' award-winning MixPre Series has been redesigned for increased performance and an astounding 142 dB of dynamic range.

The MixPre II is highly customizable to your needs. Record internally to a compatible SD card on set or stream your podcast over USB to your computer at home. Power with your computer, wall power, or record in the middle of nowhere with AA or Sony L-mount batteries. Adjust limiters, bit depth, sample rates, gain, pan, low-cut, phase inversion and phantom power to your liking. Use the MixPre's high-precision internal timecode generator to trigger the camera, or feed timecode in. The choice is yours!

Professionals love the flexibility of the MixPre Series. Don't need all those options? Basic mode has you covered.

All models are rugged, lightweight, and small, so you can throw it in a bag or mount it to a tripod or camera - or get situated on set with our Wingman App and one of our four supported USB control surfaces. With the superior sound and build quality that you can expect from the industry leader in production audio recording, your MixPre II can capture audio for any application. Our friendly and knowledgeable support team, based in the USA and the UK, is here for all your questions and comments. Our job is to make your job easier.

We are honored to be part of your kit.

Sincerely,
Sound Devices

Customize With Plugins

All plugins may be purchased and downloaded from the Sound Devices Store.

Musician Plugin

Easily create a song using the MixPre as a standalone recorder or USB interface. Use onboard features like overdub, bounce, reverb, and tracking to a metronome.

Ambisonics Plugin

Record 360° audio and monitor binaurally with this plugin, an ambisonic microphone, and your MixPre-6 II or MixPre-10 II.

MixAssist Plugin

Using multiple microphones with your MixPre? Enable MixAssist to reduce unwanted microphone and room noise while recording.

NoiseAssist Plugin (One or two instance versions available)

Suppress background noise instantly on-location with the NoiseAssist plugin for MixPre II Series. A one instance or two instance NoiseAssist plugin can be purchased. Instances can run on any channel, bus L, or bus R.

Reporter Plugin

Simplify the settings of your MixPre so your contributors can focus on capturing great content. The Reporter plugin allows you to configure your MixPre-3 II or MixPre-6 II in advance and then lock the menus. Send it off with a journalist, interviewee, or other contributor in confidence!

+2ch Plugin (MixPre-3 only)

Adds 2 channels for a total of 5 channels and 7 tracks.

Panel Views

MixPre-3 II

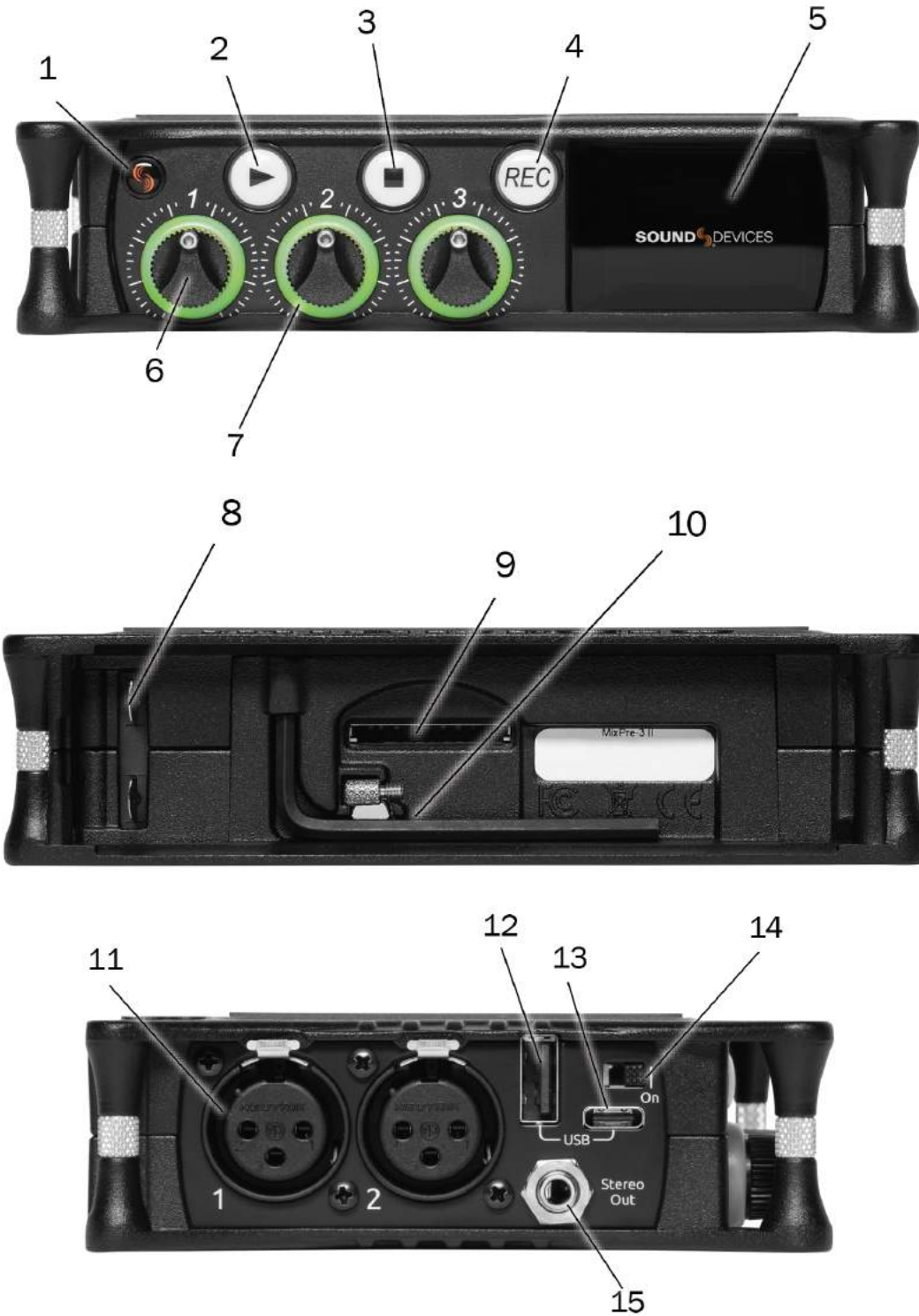

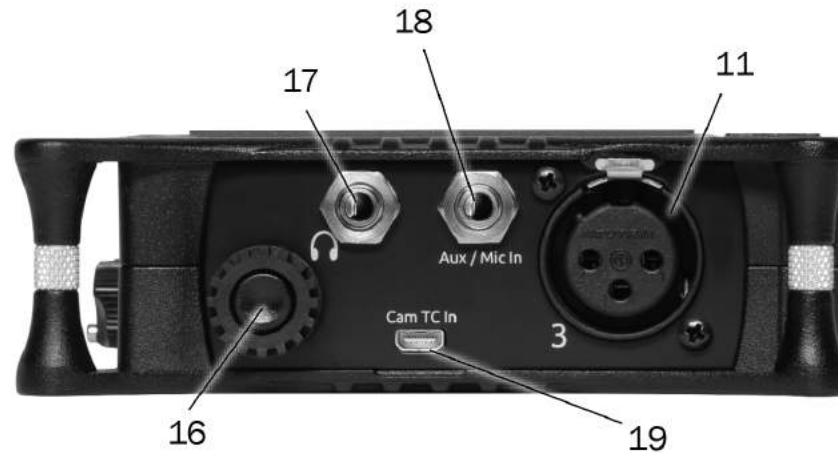

1: Power LED

Glows when the MixPre II is powered on.

2: Play Button

Press to begin playback. While in playback the button glows green. See Transport.

3: Stop Button

Press to stop recording or playback. While stopped the button glows orange. See Transport.

4: Record Button

Press to begin a recording. While recording the button glows red. While copying in idle, the button flashes red. See Transport.

5: Touch Screen

The sunlight-viewable, high-resolution, touch-screen is used to navigate the MixPre II user interface.

6: Channel Knobs

Sets the input gain for the channel. Press in on knob to access channel screen.

7: Channel LED Ring

Provides visual indication of channel signal condition, solo and mute.

8: Battery Contacts

Accepts power sled accessories designed for MixPre II. Allows powering from AA or Sony L-Mount batteries, such as the included MX-4AA.

9: SD Card Slot

Insert SD card for recording.

10: Allen Wrench & Anti-Rotational Pin

Magnetically attaches to the MixPre II for safe keeping. Used to attach MixPre II to cameras and tripods via ¼-inch-20-thread captive screw on MixPre II top panel.

11: Inputs 1-3 Female XLR Jacks

Active-balanced analog microphone or line-level inputs. Inputs 1-2 on left panel, input 3 on the right. [pin-1 = ground, pin-2 = hot (+), and pin-3 = cold (-)]

12: USB-A Port

1. USB keyboard.
2. Auto-copy to USB drives.
3. USB to approved 3rd party control surfaces.
4. USB hubs to support multiple devices.

13: USB-C Port

1. Provides power to the unit.
2. Connects to computer as a USB Audio Interface.
3. Connects to computer for transferring files from the SD card.

14: Power Switch

Turns the power on and off.

15: Stereo Audio, Timecode, or Split Audio/Timecode Output

Unbalanced stereo 3.5 mm female connector. Routing determined in the Outputs menu. [Sleeve = ground, tip = X1, ring = X2].

16: Headphone Knob

1. Rotate to control headphone volume.
2. Rotate to navigate some menus and the virtual keyboard. Press in to select items.
3. Press during playback to enter scrub mode. Rotate to scrub forwards or backwards at different speeds.
4. Press simultaneously with Ch1 or Ch2 knob to jump directly to the extra channel input settings menus.

17: Headphone Output

3.5 mm TRS headphone output. Warning! This output can drive headphones to potentially dangerous levels. [Sleeve = ground, tip = left, ring = right]

18: Aux/Mic/Timecode Input

Menu-selectable input. Accepts unbalanced stereo audio signal, Plug in Power microphones, or LTC timecode.

19: HDMI TC Input

Connect to select cameras to receive HDMI timecode and record start/stop flags.

MixPre-6 II

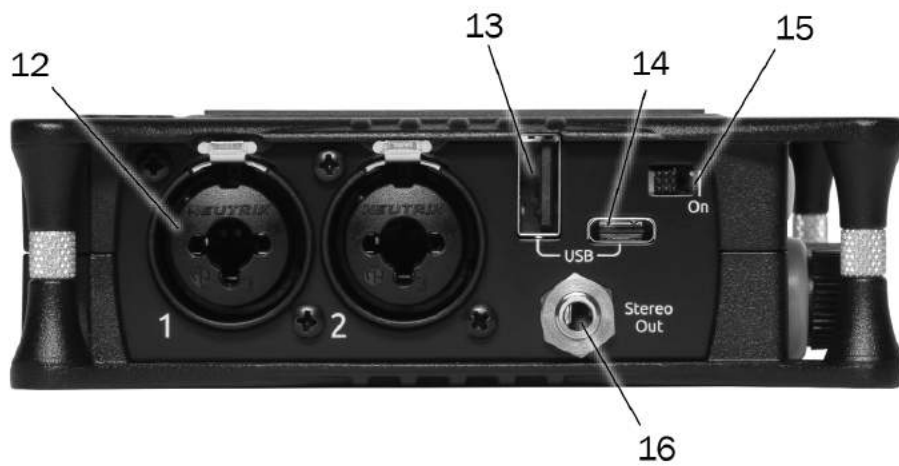
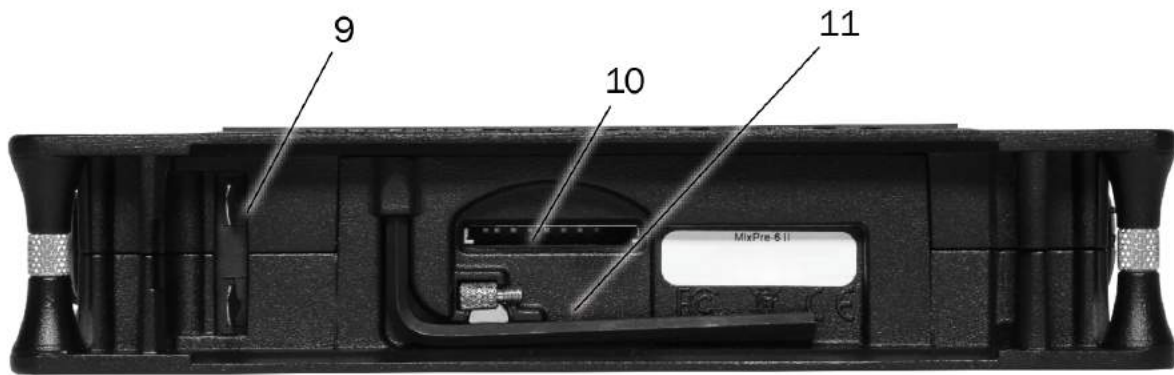
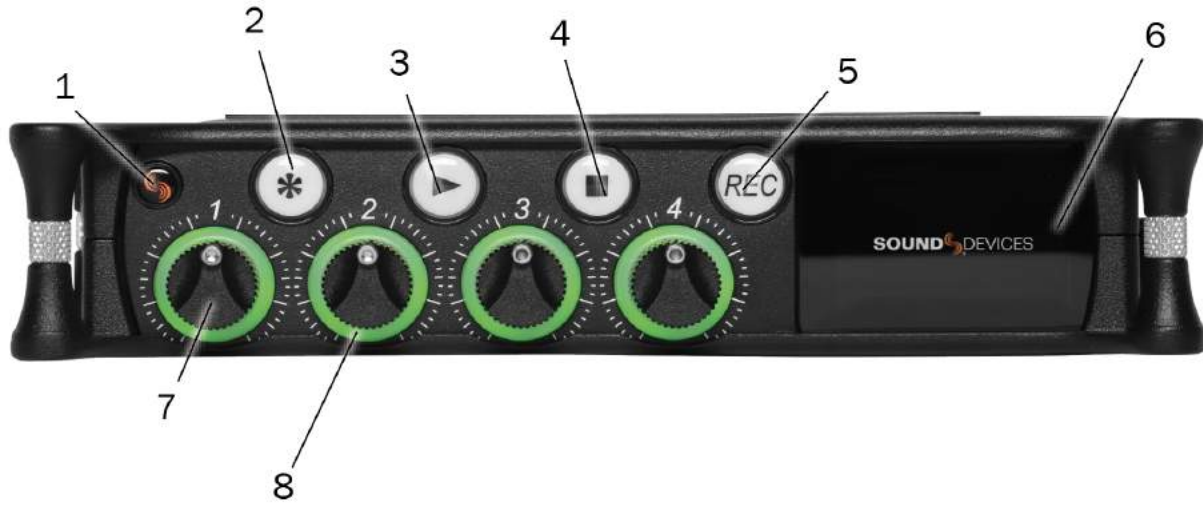

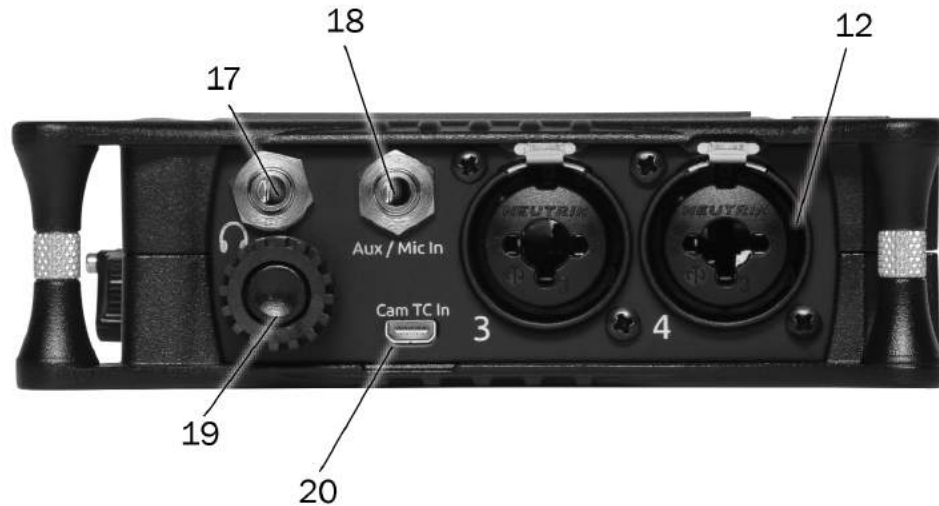

1: Power LED

Glows when the MixPre II is powered on.

2: Star (* & **) Button

Provides a user-assignable hardware button to frequently used functions. See Shortcuts.

3: Play Button

Press to begin playback. While in playback the button glows green. See Transport.

4: Stop Button

Press to stop recording or playback. While stopped the button glows orange. While copying in idle, the button flashes red. See Transport.

5: Record Button

Press to begin a recording. While recording the button glows red. While copying in idle, the button flashes red. See Transport.

6: Touch Screen

The sunlight-viewable, high-resolution, touch-screen is used to navigate the MixPre II user interface.

7: Channel Knobs

Sets the input gain for the channel. Press in on knob to access channel screen. Press simultaneously along with the headphone knob on the right side panel to jump directly to the extra channel screens.

8: Channel LED ring

Provides visual indication of channel signal condition, solo and mute.

9: Battery contacts

Accepts power sled accessories designed for MixPre II. Allows powering from AA or Sony L-Mount batteries, such as the included MX-4AA.

10: SD Card Slot

Insert SD card for recording.

11: Allen Wrench & Anti-Rotational pin

Magnetically attaches to the MixPre II for safe keeping. Used to attach MixPre II to cameras and tripods via 1/4-inch-20-thread captive screw on MixPre II top panel.

12: Inputs 1-4 female XLR / 1/4" TRS Combo jacks

Active-balanced analog microphone or line-level inputs. Inputs 1-2 on left panel, inputs 3-4 on the right. [pin-1 = ground, pin-2 = hot (+), and pin-3 = cold (-)]

13: USB-A Port

1. USB keyboard.
2. Auto-copy to USB drives.
3. USB to approved 3rd party control surfaces.
4. USB hubs to support multiple devices.

14: USB-C Port

1. Provides power to the unit.
2. Connects to computer as a USB Audio Interface.
3. Connects to computer for transferring files from the SD card.

15: Power Switch

Turns the power on and off.

16: Stereo Audio, Timecode, or Split Audio/Timecode Output

Unbalanced stereo 3.5 mm female connector. Routing determined in the Outputs menu. [Sleeve = ground, tip = X1, ring = X2].

17: Headphone Output

3.5 mm TRS headphone output. Warning! This output can drive headphones to potentially dangerous levels. [Sleeve = ground, tip = left, ring = right]

18: Aux/Mic/Timecode Input

Menu-selectable input. Accepts unbalanced stereo audio signal, Plug in Power microphones, or LTC timecode.

19: Headphone knob

1. Rotate to control headphone volume.
2. Rotate to navigate some menus and the virtual keyboard. Press in to select items.
3. Press simultaneously with channel knobs 1 and 2 to access the channel screens of the extra channels.

20: HDMI TC Input

Connect to select cameras to receive HDMI timecode and record start/stop flags.

MixPre-10 II

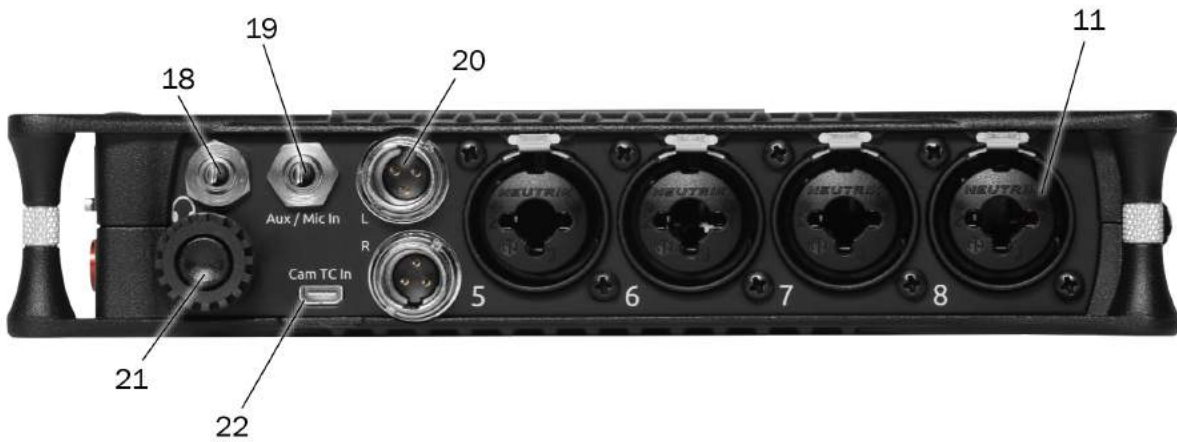
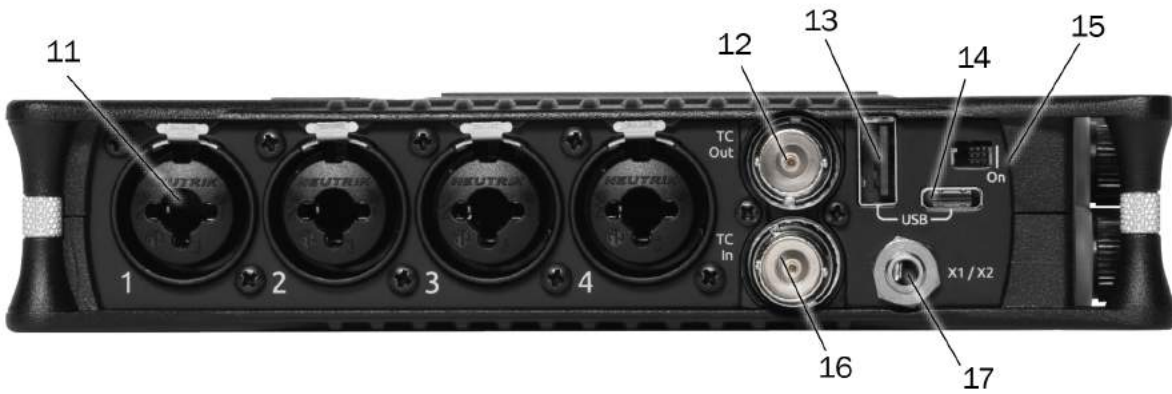
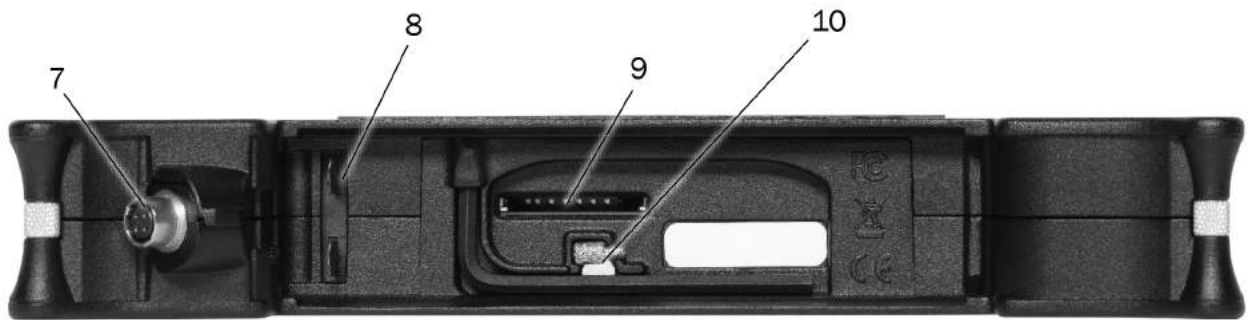
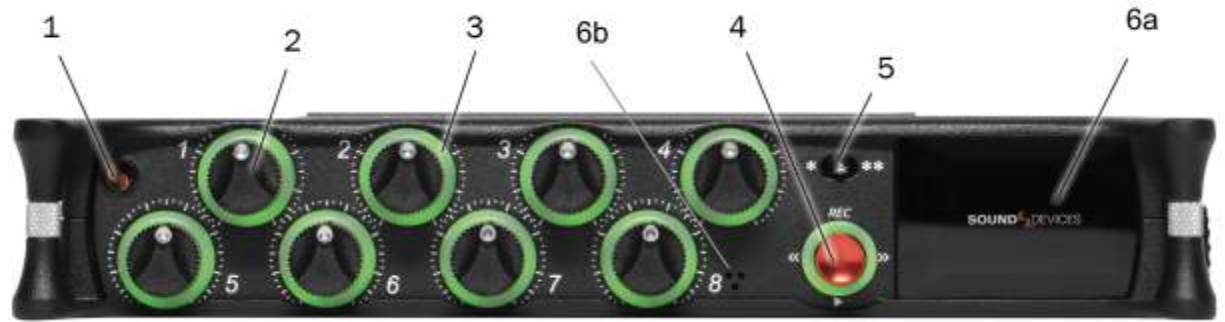

1: Power LED

Glows when the MixPre II is powered on.

2: Channel Knobs

Sets the input gain for the channel. Press in on knob to access channel screen. Press headphone knob simultaneously with channel knobs 1 and 2 to access the channel screens of the extra channels.

3: Channel LED Ring

Provides visual indication of channel signal condition, solo and mute.

4: Transport Controls

A joystick (with its illuminated LED ring) on the front panel is used to perform various transport control functions. (see Transport).

5: Star (* & **) Switch

Provides a user-assignable hardware switch to frequently used functions. See Shortcuts.

6a: Touch Screen

The sunlight-viewable, high-resolution, touch-screen is used to navigate the MixPre II user interface.

6b: Slate Mic

Built in slate mic that can be activated using the */** switch.

7: 4-Pin Hirose DC Input

Accepts DC voltages from 10–17 V for powering. [pin-4=+, pin-1=-] Works with included XL-WPH3.

8: Battery Contacts

Accepts power sled accessories designed for MixPre II. Allows powering from AA or Sony L-Mount batteries, such as the included MX-8AA.

9: SD Card Slot

Insert SD card for recording.

10: Allen Wrench & Anti-Rotational Pin

Magnetically attaches to the MixPre II for safe keeping. Used to attach MixPre II to cameras and tripods via ¼-inch-20-thread captive screw on MixPre II top panel.

11: Inputs 1-8 Female XLR / 1/4" TRS Combo Jacks

Active-balanced analog microphone or line-level inputs. Inputs 1-4 on left panel, inputs 5-8 on the right. [pin-1 = ground, pin-2 = hot (+), and pin-3 = cold (-)].

12: BNC Timecode or Word Clock Output

Menu-selectable between timecode or word clock functionality. Set to timecode to send LTC timecode to cameras, digi-slates or other timecode-enabled equipment. Set to word clock to use the MixPre-10 II as a master precision clock source for external equipment.

13: USB-A Port

1. USB keyboard.
2. Auto-copy to USB drives.
3. USB to approved 3rd party control surfaces.
4. USB hubs to support multiple devices.

14: USB-C Port

Used to connect to a computer for USB audio or transferring files from the SD card.

15: Power Switch

Turns the power on and off.

16: BNC Timecode or Word Clock Input

Menu-selectable between timecode or word clock functionality. Set to timecode to receive LTC timecode from a camera or timecode generator. Set to word clock to sync to an external clock source.

17: X1/X2 Output

Unbalanced stereo 3.5 mm female connector. Routing determined in the Outputs menu. [Sleeve = ground, tip = X1, ring = X2].

18: Headphone Output

3.5 mm TRS headphone output. Warning! This output can drive headphones to potentially dangerous levels. [Sleeve = ground, tip = left, ring = right]

19: Aux/Mic/Timecode Input

Menu-selectable input. Accepts unbalanced stereo audio signal, Plug in Power microphones, or LTC timecode.

20: Left & Right TA3 Outputs

+18 dBu line level outputs. Routing determined in the Outputs menu. [pin-1 = Ground, pin-2 = hot (+), pin-3 = cold (-). Float pin-3 to unbalance]

21: Headphone Knob

1. Rotate to control headphone volume.
2. Rotate to navigate some menus and the virtual keyboard. Press in to select items.
3. Press simultaneously with channel knobs 1 and 2 to access the channel screens of the extra channels.

22: HDMI TC Input

Connect to select cameras to receive HDMI timecode and record start/stop flags.

Powering the MixPre II

Apply your choice of power source. Turn the master power switch located in the upper right corner of the left side panel to the On position. To ensure the battery/power status indicator displayed on the touchscreen shows accurate level and status, select your battery/ power type in the Power menu.

When using AA batteries to power the MixPre II, we recommend Energizer Ultimate Lithium (not alkaline batteries). The high internal resistance of alkaline batteries makes them only suited to devices requiring low current (less than 25 mA), not higher power electronic devices such as the MixPre II.

Incorrect use of batteries poses a danger of explosion. Replace only with the same or equivalent type. Properly recycle batteries. Do not crush, disassemble, incinerate, dispose in a fire or expose batteries to high temperatures.

Save power by turning off unused channels.

With multiple options for powering, your MixPre II can operate in a wide array of applications and environments.

MixPre-3 II and MixPre-6 II Power Options

1. Included MX-PSU AC wall adapter to USB-C power supply.
2. Four AA batteries installed in the included MX-4AA Battery Sled.
3. Eight AA batteries installed in the optional MX-8AA Battery Sled accessory.
4. One or two Sony-type L-Mount batteries installed in the optional MX-LMount battery sled accessory.
5. USB-C to USB-C cable (included) connected to a USB-C host computer or AC wall adapter.
6. USB-A to USB-C cable connected to a USB-A host computer or AC wall adapter. The unit will enter a low power state and some functionality will be limited with this power option.
7. MX-USBY Dual USB-A to USB-C optional accessory cable connected to a USB-A host computer. Use this cable option if your computer is unable to provide adequate power with only one USB-A port.

MixPre-10 II Power Options

1. Included XL-WPH3 AC to DC 12 V Power supply with 4-pin Hirose.
2. Eight AA batteries installed in the included MX-8AA Battery Sled.
3. One or two Sony-type L-Mount batteries installed in the optional MX-LMount battery sled accessory.

Power Switchover and Priority

MixPre-3 II and MixPre-6 II

To preserve battery power, USB-C power sources take priority over batteries if both are connected with one exception - if the USB-C power source does not meet the full power requirements of the MixPre II, you can choose to power from battery or continue to power from USB-C. An underpowered MixPre II will be able to use two of the three or four channels with 48 V phantom mics. Other channels can still be used with dynamic mics and line level, Aux, or USB sources. In a low power state, the MixPre II automatically:

1. Dims LCD and LED Brightness.
2. Disables USB-A port.
3. Disables HDMI TC port.

For protection against accidental loss of power, the MixPre II incorporates circuitry to automatically switch over from USB-C to batteries.

MixPre-10 II

For preservation of battery power, 4-pin Hirose power sources take priority over batteries if both are connected. For protection against accidental loss of power, the MixPre-10 II incorporates circuitry to automatically switch power sources.

Touchscreen

The MixPre II has a sunlight-viewable, high-resolution, touch-screen-based user interface, which consists of the Home screen, Main Menu screen, and Channel screen views. There are several touch zones on the touch screen for controls. As you become familiar with the user interface, changing settings for inputs, outputs, recording and metering will become fast and intuitive.

Home Screen

The Home screen view appears on the touchscreen when the device is powered up.



1: File List Icon

Touch to enter the File List.

2: Current File Name

Displays the current file name.





3: Cue Marker Icon

Touch to lay a cue marker during record or playback. Displays current cue mark point.

4: Power Status Icon

Displays the status of the active power source. See tables opposite for further details.

MixPre-3 II and MixPre-6 II

Power Status Icon	Description
 (Green USB)	USB power source is ideal.
 (Orange USB)	USB power source low. Brightness dimmed, HDMI & USB-A ports disabled, 48 V phantom on 2 channels only.
 (Green Battery)	Healthy battery. Plan to change batteries when green level drops to about ¼ full. 48 V phantom on 2 channels only.
 (Flashing Red Battery)	Battery power is critically low. Change batteries.

MixPre-10 II

Power Status Icon	Description
 (Green Battery)	Healthy battery. Plan to change batteries when green level drops to about ¼ full.

 (Flashing Red Battery)	Battery power is critically low. Change batteries.
----------------------------------------------------------------------------------------------------------	----------------------------------------------------

5: Menu Icon

Touch to enter the setup menu.

6: Meter View

Displays audio activity. Touch to toggle through available meter views:

1. Left and Right mix tracks.
2. Left and Right mix tracks with isolated tracks.
3. Left and Right mix tracks, USB inputs 1 and 2, and 2 camera returns (when Aux inputs are set to camera).

7: Status Bar

Touch to toggle information displayed:

1. SD card status: card/drive activity, available recording time, file duration, elapsed time, and headphone preset.
2. USB drive status: remaining space on drive, sample rate, bit depth.
3. Sync Source (if external), sample rate, and bit depth.
4. Date and time.

While auto-copying, copy status is displayed on all status bars. Copy status will alternate with default info.





8: Time Counter

Displays current timecode value. If timecode is Off, displays time counter of recording file.

Transport Controls







MixPre-3 II and MixPre-6 II

The three Transport controls (illuminated buttons) on the front panel are used to perform recording and playback functions.

Function	Control	Action
Record		Press to begin recording a new file. The button illuminates red while recording is in underway. In Stop mode the record button flashes red while auto-copying to a USB thumb drive.
Stop		While recording, press once to stop recording. While in playback, press once to stop playback. While in standby, press and hold to display next name. While in Standby and auto-copying is in progress, press Stop to optionally suspend auto-copying.
Play/Pause		Press to begin playback of the last file recorded or file currently loaded. The button illuminates green during playback. While in playback, press once to pause, and press again to resume playback. Whenever playback is paused, the button and the current file name will flash green.
Scrub		While playing or paused, press and hold the headphone encoder to enter Scrub mode. Then rotate clockwise for fast forward or counter-clockwise for rewind at speeds of 0x, 1/8x, 1/4x, 1/2x, 1x, 2x, 4x, 8x and 16x. The audio is heard in Scrub mode up to 2x speed. Scrubbing at speeds < 1x are not available with 32-bit float.





MixPre-10 II

The three Transport controls (illuminated buttons) on the front panel are used to perform recording and playback functions.

Function	Control	Action
Record		Push up the Transport control to begin recording a new file. The LED ring illuminates red while recording is underway.
Stop		Press in the Transport control to stop recording or playback. While in standby, press and hold to display next take name. The LED flashes red while auto-copying to a USB thumb drive. While in Standby and auto-copying is in progress, press Stop to bring up a dialogue box which gives the option to suspend auto-copying.
Play		Push down the Transport control to begin playback of the last file recorded or file currently loaded. While in playback, push down again to pause playback. The LED ring as well as the active file in the display will flash to indicate that Pause is active. Push down again to continue playback.
Rewind / Load previous take		While in standby, push left to load the previous take. While in playback, push and hold left to rewind. When the MixPre is playing back or paused, moving the joystick to the left (<<) rewinds at 2x speed, then after holding for 5 seconds, it increases to 16x speed.
Fast forward / Load next take		While in standby, push right to load the next take. While in playback, push and hold right to fast forward. When the MixPre is playing back or paused, moving the joystick to the right (>>) fast forwards at 2x speed, then after holding for 5 seconds, it increases to 16x speed.
Scrub		While playing or paused, press and hold the headphone encoder to enter Scrub mode. Then rotate clockwise for fast forward or counter-clockwise for rewind at speeds of 0x, 1/8x, 1/4x, 1/2x, 1x, 2x, 4x, 8x and 16x. The audio may be heard in Scrub mode up to 2x speed. Scrubbing at speeds < 1x are not available with 32-bit float.

Navigating Menus

Most features and functions are selected and set up in the Menu.

Icon	Function
	Touch the Menu icon from the Home Screen to enter the Menu.
	Touch the Back icon to return to the main Menu from any submenu.
	Touch the Home icon to immediately return the Home Screen.
	Touch the Page (dots) icon to view the next page of options.
	Touch the Headphone icon to enter the Headphone menu.

Main Menu Screen

Touch any menu item to enter the submenu. The menus available depend on model and Mode. See Choosing Your Mode for more information.



Front Panel Locks

All MixPre mixer-recorders can lock the front panels controls to prevent accidental adjustments.

Press channel knobs 1, 2 and 3 simultaneously to enter the Front Panel Menu.

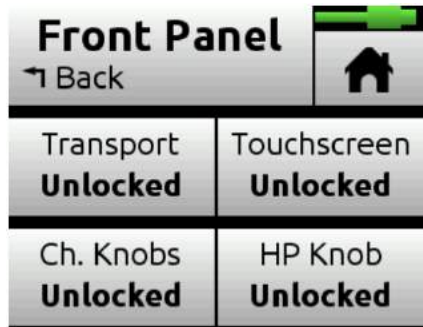

Transport

Locks or unlocks transport controls on the MixPre. (Locked, Unlocked*)

MixPre-3 II

Play, Stop, Record, and scrub mode on headphone knob. (Locked, Unlocked*)

MixPre-6 II

Play, Stop, Record, scrub mode on headphone knob, and the * shortcut. (Locked, Unlocked*)

MixPre-10 II

All joystick controls (record, stop, play, rewind, ff), and */** toggle. (Locked, Unlocked*)

Touchscreen

Locks or unlocks all touch activity of the LCD for all models. (Locked, Unlocked*)

CH. Knobs

Locks or unlocks the front panel gain knobs from making level adjustments and entering the channel screens for all models. (On, Off*)

HP Knob

Locks or unlocks headphone knob press and rotate functions. (Locked, Unlocked*)

If any parameter change is attempted while locked, a popup will appear. Enter the Front Panel Menu and toggle that parameter option Off to regain control of that parameter.

Controls from the Wingman application, USB keyboard or USB MIDI controllers are unaffected by Front Panel Lock Mode.

All Front Panel functions are unlocked when the MixPre is rebooted.

Choosing Your Mode

The MixPre II has three different modes of operation to suit you and your application: Basic, Advanced, and Custom. Basic mode is intended for simple, hassle-free, plug-and-play use and beginners. Advanced mode is for professionals and anyone who wants to have every available setting and option at their disposal. Custom mode allows you to select your own mixture of basic and advanced operation.

The MixPre-3 II and MixPre-6 II default to Basic mode. The MixPre-10 II defaults to Advanced mode. To change mode, go to Menu>System>Mode.

MixPre-3 II Basic VS Advanced

Feature	Basic	Advanced	
Gain	Channel knob controls all gain for a channel.	Dual gain stage. Input gain is set in the Channel Screen. Channel knob controls post-fade levels to mix bus.	
Channel Screen Options	Pan (Left, Center, Right) Input Phantom Low Cut (On or Off)	Solo Mute Track Arm (Iso Tracks) Gain Pan (variable options) Input	Phantom Low Cut (variable options) Phase Delay NoiseAssist (requires plugin) Stereo and MS Linking (ch1-2 only)
Headphone Options	LR Stereo USB 1,2	LR Stereo LR Mono USB 1,2 Presets 1-4 Edit Presets	Camera Stereo Camera Mono HP Solo mode (Multiple or Individual)
Outputs	Fixed routing of LR mix	Stereo Output flexible routing Stereo Output gain Stereo Out Mode (LTC, Audio, or Split)	Stereo Out Mute L,R Delay USB Output 1-6
File List Options	Name Number Trash File Cue Move Cue Name Cue Delete	Undo Recording Name Number Notes Track Names	Trash File Cue Move Cue Name Cue Delete
Aux In Options	Mic Line Timecode Aux In 1 and 2 Off	Mic Line Timecode Aux In 1 and 2 Camera Return Off	
MixAssist	Not Available	Requires Plugin	
NoiseAssist	Not Available	Requires Plugin	
Record Options	Sample Rate fixed at 48 kHz Bit Depth fixed at 24 bit Records only the Left/Right mix Pre-roll Record Triggers Record Bells	Sample Rate Options 44.1 - 192 kHz Bit Depth options 16, 24, 32 (float) Record Isolated channels and mix tracks Individual control of Left and Right gain Individual control of Left and Right record arming Pre-roll Record Triggers Record Bells Remix & Rerecord NoiseAssist, Left and Right (requires plugin)	
Limiters	Always On	Limiters (Off, Factory, Custom) Custom Limiter options (Ratio, Threshold, Release)	

MixPre-6 II Basic VS Advanced

Feature	Basic	Advanced	
Gain	Channel knob controls all gain for a channel.	Dual gain stage. Input gain is set in the Channel Screen. Channel knob controls post-fade levels to mix bus.	
Channel Screen Options	Pan (Left, Center, Right) Input Phantom Low Cut (On or Off)	Solo Mute Track Arm (Iso Tracks) Gain Pan (variable options) Input	Phantom Low Cut (variable options) Phase Delay NoiseAssist (requires plugin) Stereo and MS Linking
Headphone Options	LR Stereo USB 1,2 USB 3,4	LR Stereo LR Mono USB 1,2 USB 3,4 Presets 1-4	Edit Presets Camera Stereo Camera Mono HP Solo mode (Multiple or Individual)
Outputs	Fixed routing of LR mix	Stereo Output flexible routing Stereo Output gain Stereo Out Mode (LTC, Audio, or Split)	Stereo Out Mute L,R Delay USB Outputs 1-8
File List Options	Name Number Trash File Cue Move Cue Name Cue Delete	Undo Recording Name Number Notes Track Names	Trash File Cue Move Cue Name Cue Delete
Aux In Options	Mic Line Timecode Aux In 1 and 2 Off	Mic Line Timecode Aux In 1 and 2 Camera Return Off	
Ambisonics	Not Available	Requires Plugin	
MixAssist	Not Available	Requires Plugin	
NoiseAssist	Not Available	Requires Plugin	
Record Options	Sample Rate fixed at 48 kHz Bit Depth fixed at 24 bit Records only the Left/Right mix Pre-roll Record Triggers Record Bells	Sample Rate Options 44.1 - 192 kHz Bit Depth options 16, 24, 32 (float) Record Isolated channels and mix tracks Individual control of Left and Right gain Individual control of Left and Right record arming Pre-roll Record Triggers Record Bells Remix & Rerecord NoiseAssist, Left and Right (requires plugin)	
Tone Menu	On or Off	On or Off L Ident Tone Tone Level	
Limiters	Always On	Limiters (Off, Factory, Custom) Custom Limiter options (Ratio, Threshold, Release)	

MixPre-10 II Basic VS Advanced

FEATURE	BASIC	ADVANCED	
Gain	Channel knob controls all gain for a channel.	Dual gain stage. Input gain is set in the Channel Screen. Channel knob controls post-fade levels to mix bus.	
Channel Screen Options	Pan (Left, Center, Right) Input Phantom Low Cut (On or Off)	Solo Mute Track Arm (Iso Tracks) Gain Pan (variable options) Input	Phantom Low Cut (variable options) Phase Delay NoiseAssist (requires plugin) Stereo and MS Linking
Headphone Options	LR Stereo X1X2 Stereo USB 1,2 USB 3,4	LR Stereo LR Mono X1X2 Stereo USB 1,2 USB 3,4 Presets 1-4	Edit Presets Camera Stereo Camera Mono HP Solo mode (Multiple or Individual)
Outputs	Fixed routing of LR mix	L,R and X1,X2 flexible routing L,R and X1,X2 gain L,R and X1,X2 Out Mute L,R and X1,X2 Delay USB Outputs 1-12	
File List Options	Name Number Trash File Cue Move Cue Name Cue Delete	Undo Recording Name Number Notes Track Names	Trash File Cue Move Cue Name Cue Delete
Aux In Options	Mic Line Timecode Aux In 1 and 2 Off	Mic Line Timecode Aux In 1 and 2 Camera Return Off	
Ambisonics	Not Available	Requires Plugin	
MixAssist	Not Available	Requires Plugin	
NoiseAssist	Not Available	Requires Plugin	
Record Options	Sample Rate fixed at 48 kHz Bit Depth fixed at 24 bit Records only the Left/Right mix Pre-roll Record Triggers Record Bells	Sample Rate options 44.1 - 192 kHz Bit Depth options 16, 24, 32 (float) Record Isolated channels and mix tracks Individual control of Left and Right gain Individual control of Left and Right record arming Pre-roll Record Triggers Record Bells Remix & Rerecord NoiseAssist, Left and Right (requires plugin)	
Tone Menu	On or Off	Flexible Tone Routing Tone Level L Ident Tone Tone Level	
Limiters	Always On	Limiters (Off, Factory, Custom) Custom Limiter options (Ratio, Threshold, Release)	

Custom Mode

Custom mode allows you to select your own mixture of basic and advanced operation. This mode grants access to select categories of Advanced Mode.

Configure Custom Setup

1. Set System > Mode to Custom.
2. In System > Custom Setup set each category to basic or advanced.

Custom Setup options are:

Category	Description
Channel	Allows advanced operation of the following items: Channel Solo, Mute, Track Arm, Pan, Low Cut, Phase, Delay, NoiseAssist (requires plugin), Channel Linking, and isolated track recording.
Gain	Allows advanced operation of channel gain, including dual gain stage (gain and fader) and Remix.
Headphone	Allows access to advanced headphone presets and channel solo.
Record	Allows advanced operation of isolated track arming and recording, LR track linking and gain, sample rate, and bit depth.
Metadata	Allows advanced operation in the File List. This includes metadata entry and editing of name, number, notes, track names, and access to the undo recording feature.
Outputs	Allows advanced operation of Output menu items such as mute, gain, mode, and routing.

Channel Screen - Basic Mode

The MixPre II's flexibility is enhanced by its ability to select various input types to its mixer channels. On the MixPre-3 II, channels can be sourced from XLR mic/line input, 3.5 mm Aux line or mic input, or from USB channels. On the MixPre-6 II and MixPre-10 II, channels can be sourced from XLR or TRS mic/line input, 3.5 mm Aux line or mic input, or from USB channels.

Access the channel's input settings by pushing in the channel's knob. There are 3 channel inputs on the MixPre-3 II, 5 channel inputs on the MixPre-3 II with +2ch plugin, 6 channel inputs on the MixPre-6 II, and 10 channel inputs on the MixPre-10 II.

Settings for extra channels 4-5 on the MixPre-3 II with +2ch plugin, ch 5-6 on MixPre-6 II, and ch 9-10 on the MixPre-10 II are accessed from the Inputs menu. Input source, gain, pan, and low cut are all available in this menu.

Tip: To quickly access these extra channels' input settings without having to go via the Inputs menu, simultaneously press HP knob and the Ch 1 or Ch 2 knobs.

Channels use a single gain stage adjusted by the knob. Levels set at the channel knob are sent to the LR mix record channels and the LR outputs. Limiters are present on each channel and the LR mix bus and will ensure that your audio is safe from accidental clipping.

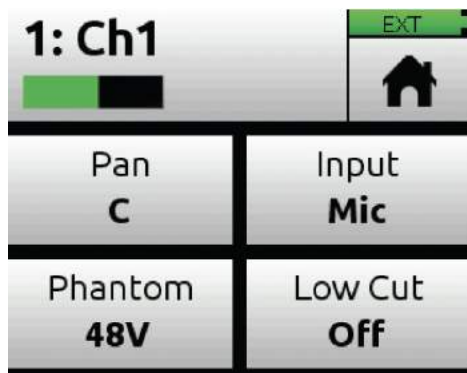

Pan

Pan the channel's signal Left, Center or Right in the stereo LR mix and Stereo Out.

Low Cut

Turn Low Cut filter on or off. Useful for reducing unwanted low frequency in the audio of the select channel. In Basic Mode Low Cut is fixed at 80 Hz. Low Cut is not available for USB input sources.

Input

Select one of the available Mic, Line, Aux (available when Aux In Mode is Mic or Line) or USB inputs as the channel source.

Input Types	Description
Mic	Use for microphones. For condenser mics requiring 48 V phantom power, set Phantom to On.
Line	Use this type for balanced analog line level sources.
Aux In	Use for unbalanced stereo input. Aux In 1 or Aux In 2
USB	Use for sources coming from a computer via USB-C. Select USB 1 or 2 and if a MixPre-6 or 10, USB 3 or 4.

Phantom

Turn on 48 V phantom power when using a condenser microphone in the selected channel (available when Input is Mic).

Channel Screen - Advanced Mode

The MixPre II's flexibility is enhanced by its ability to select various input types to its mixer channels. On the MixPre-3 II, channels can be sourced from XLR mic/line input, 3.5 mm Aux line or mic input, or from USB channels. On the MixPre-6 II and MixPre-10 II, channels can be sourced from XLR or TRS mic/line input, 3.5 mm Aux line or mic input, or from USB channels.

Access the channel's input settings by pushing in the channel's knob. There are 3 channel inputs on the MixPre-3 II, 5 channel inputs on the MixPre-3 II with +2ch plugin, 6 channel inputs on the MixPre-6 II, and 10 channel inputs on the MixPre-10 II.

Settings for extra channels 4-5 on the MixPre-3 II with +2ch plugin, ch 5-6 on MixPre-6 II, and ch 9-10 on the MixPre-10 II are accessed from the Inputs menu. Input source, solo, mute, arm, gain, pan, low cut, and linking* are all available in this menu.

Tip: To quickly access these extra channels' input settings without having to go via the Inputs menu, simultaneously press HP knob and the Ch 1 or Ch 2 knobs.

*Note: The MixPre-3 (I or II series) with +2ch plugin does not support linking for channels 4 and 5.

Channels use a dual gain stage. Adjust the gain control in the Channel Screen and fader level with the knob. Limiters are present on each channel and the LR mix bus and will ensure that your audio is safe from accidental clipping.

Solo

Lets you "solo" the selected channel in the headphone output. Solo mode can be set to "Individual" or "Multiple" in the HP menu. When a channel is soloed, the LED ring will flash orange.

Mute

Provides quick access to muting an input.

Arm

Allows pre-fade recording of the channel to an individual track on the SD card.

Gain

Sets the sensitivity of the input. Generally, the Gain should be set so that the loudest parts of the audio signal just touch the red segments of the meters. The control knobs on the front panel act as faders.

Pan

Lets you position the audio of the channel anywhere between Left and Right in the stereo image of the LR mix and Stereo Out.

Low Cut

Turn Low Cut filter on or off. Useful for reducing unwanted low frequency in the audio of the select channel. Frequency is adjustable from 40, 80, 100, 120, or 160 Hz. Low Cut is not available for USB input sources.

Input

Select one of the available Mic, Line, Aux In 1, Aux In 2 (available when Aux In Mode is Mic or Line) or any USB input as the channel source.

Phantom

Turn on 48 V phantom power when using a condenser microphone in the selected channel (available when Input is Mic)

Phase

Phase inversion (or polarity reversal) is used to compensate for incorrectly wired, balanced cables, to prevent signal cancellation when a source is dual-mic'd from opposite directions, or to reverse left/right with microphones in a mid-side (MS) configuration.

Delay

Input delay may be used to compensate for 'phasey' sounding audio because of time-of-arrival differences between sound sources, such as a boom mic and wireless radio mic picking up the same sound source.

NOISEASSIST (Requires Plugin)

Sets the amount of noise suppression applied to a channel. Adjust from 0 dB (no suppression) to -20 dB (maximum suppression) in 1 dB steps. Only available when the channel is selected in the System > NoiseAssist menu.

Linking

Odd-even channel pairs can be linked as a stereo pair or mid side pair.



Linking Channels

Are you working with a stereo source—a keyboard or stereo mic perhaps? To make it easier to adjust these types of sources, the MixPre II offers linking of channel pairs (1-2, 3-4 ...) either as a stereo pair or mid-side (MS) pair.

Note: The MixPre-3 (with or without +2ch plugin) offers only linking of channels 1-2.

Stereo Pair Linking

Control the level of both the first and second channels with the first (odd-numbered) Channel knob. The second (even-numbered) Channel knob functions as a balance control.

MS Pair Linking

Control the level of both the first and second channels with the first (odd-numbered) Channel knob. The second (even-numbered) Channel knob functions as a width control. You can choose to have the MS decoder apply to the mix only or both ISOs and mix in the menu Inputs > MS Decode.

Multichannel Linking

When multiple channels are linked, gain, fader, limiters, track arming, low cut filters, and input delay are all linked and controlled from the first Channel. Additionally, the Link Type menu provides the options for which parameters are linked.

All links input type, trim gains, faders, limiters, low cuts, record arms, and delays
Faders Only links only fader level.

The MixPre-6 II can link channels 1-3 and 1-4.

The MixPre-10 II can additionally link channels 1-3, 1-4, 1-5, 1-6, 1-7 and 1-8.

Gain Staging with Linking

You can use linking with single gain stage or two-gain stage (trim/fader) operation. For instance, users wanting to link inputs 1-2 or 1-4, but control all levels from the front-panel Channel 1 knob should set System > Mode to Custom and then in Custom Setup, set Gain to Basic and Channel to Advanced.

Users wanting to link those same inputs but use two gain stages should use Advanced Mode or Custom mode with both Gain and Channel set to Advanced. Then, you can adjust trim gain levels for linked channels from the Channel 1 screen and adjust fader levels for linked channels with the Channel 1 knob.

Inputs Menu

The Inputs menu allows you to access software-controlled channel screens (4-5 on MixPre-3 II with optional +2ch plugin, 5-6 on MixPre-6 II or 9-10 on MixPre-10 II), Aux In Mode settings, MS Decode settings, Knob Press options, Ambisonics (MixPre-6 II and MixPre-10 II only with optional Plugin), and MixAssist (with optional Plugin).

Software-Controlled Channel Screens

Channel screens for channels 4 and 5 on MixPre-3 II with optional +2ch plugin, channels 5 and 6 on MixPre-6 II, or channels 9 and 10 on MixPre-10 II provide access to a channel's settings and functions. This includes input source, solo, mute, arm tracks, gain, pan, low cut, linking*, and NoiseAssist attenuation (when NoiseAssist plugin is installed and routed to the channel via System>NoiseAssist menu).

*Note: The MixPre-3 (I or II series) with +2ch plugin does not support linking for channels 4 and 5.

Input Source

Selects Input source of channels 4 and 5 on MixPre-3 II with +2ch plugin, channels 5 and 6 on MixPre-6 II, or channels 9 and 10 on MixPre-10 II.

- MixPre-3 II with +2ch plugin: Off, USB 1-2, Aux In 1, or Aux In 2
- MixPre-6 II channel 5: Off, Aux In 1, Aux In 2, USB 1, or USB 3
- MixPre-6 II channel 6: Off, Aux In 1, Aux In 2, USB 2, or USB 4
- MixPre-10 II channel 9: Off, Aux In 1, Aux In 2, USB 1, or USB 3
- MixPre-10 II channel 10: Off, Aux In 1, Aux In 2, USB 2, or USB 4

AUX In Mode

Configures how the Aux/Mic In 3.5 mm connector is used.

- **Mic:** Select this option when the Aux/Mic In is to be used with a mic. The MixPre II provides bias voltage for PiP (plug-in-power) mics. Aux 1 and 2 are available as input sources to any channel.
- **Line:** Select this option when the Aux/Mic In is to be used with an unbalanced 2ch line source, such as smartphone headphone output, stereo line source, etc. Aux 1 and 2 are available as input sources to any channel.
- **Camera:** Select this option when the Aux/Mic In is to be used for monitoring a video camera's audio output via the MixPre II's headphones and camera return (C1/C2) meters located on meter view.
 - This is particularly useful when you want to use the MixPre II to drastically improve the sound quality recorded on the camera. It is common knowledge that camera mic inputs are not of high quality so by connecting your mics to the MixPre II instead, then connecting the MixPre II's L/R outputs to your camera audio input, you will achieve far superior sound quality. Then by connecting the camera's audio output to the MixPre II's Aux/Mic In, it allows you to check that the camera audio is noise and distortion-free.
 - When this option is selected an additional setting appears in the Input Menu called Camera Gain. This lets you adjust the gain of the incoming camera audio level. You also get additional camera monitoring options in the HP Presets menu.
 - When Aux In Mode is set to Camera, you cannot route Aux In to a channel and thus you cannot record it.
- **Timecode (Aux In 1 or 2):** Select this option when using an external timecode source connected to the Aux/Mic In port. The 3.5 mm TRS connector is wired to receive timecode on its tip for Aux 1 or ring for Aux 2.
 - Set Menu > Timecode > TC Mode to Aux In 1 or Aux In 2 accordingly.
 - When Aux In Mode is set to Timecode Aux in 1, Aux In 1 audio is disabled and cannot be selected as a channel's audio input source. However, Aux In 2 can still be selected as an audio input source*
 - When Aux In Mode is set to Timecode Aux in 2, Aux In 2 audio is disabled and cannot be selected as a channel's audio input source. However, Aux In 1 can still be selected as an audio input source*

** The last used Aux In Mode audio type (Mic, Line) will be used. For example, If Aux In Mode was previously set to 'Mic' before selecting 'Timecode Aux in 1', then Aux In 2's gains are configured for a mic source.*

- **Off:** Select this option to turn off the Aux/Mic Input.

MS Decode

Applies to all channel pairs that are set to MS Linked. Choose between ISOs & Mix (decodes MS source to stereo on the ISOs and the mix) and Mix Only (decodes MS to stereo into the mix only and leaves the ISOs as undecoded MS).

Knob Press

Selects the behavior of pressing a Channel Knob. Available in Advanced Mode.

1. **Ch.View:** Pressing the channel knob enters the channel view. Channel Gain is automatically selected upon entry.

2. Ch.View + Solo: Pressing the channel knob enters the channel view and automatically solos the channel. Channel Gain is automatically selected upon entry.
Setting Knob Press to Ch.View + Solo does not permit multiple HP Soloing. HP Solo mode is automatically set to 'Individual' if it was previously set to 'Multiple.'

AMBISONICS

MixPre-6 II and MixPre-10 II only. Requires plugin; see separate Ambisonics guide for more information.

MIXASSIST

Requires plugin. MixAssist is not available in Music or Ambisonics mode. See separate MixAssist guide for more information.

NOISEASSIST

Requires plugin. NoiseAssist is not available in Music or Ambisonics mode. See separate NoiseAssist guide for more information.

Metering

There are five basic methods for observing input and output levels on the MixPre II.

Channel Knob Ring LEDS

The brightness of the light ring indicates the level of the input. Green = signal present, red = signal peaking, orange = signal limiting. A channel's ring LED will flash orange when in solo and glow red when the channel is muted. With MixAssist active, the ring LED will show solid green to indicate that the channel is active.

Channel Screen Meter

The Channel screen displays the isolated channel meter in the top left-hand corner.

Home Screen Meters

To switch meter views, touch the meters to cycle through the three different views. The meters show signal levels, current arm status of each track, limiter activity, MixAssist active channel status, and NoiseAssist suppression amount.

Meter Ballistics

Audio meter ballistics is the manner in which a visual meter responds to audio signal levels. Peak-reading ballistics correspond to actual signal peaks, but do not necessarily correspond to perceived signal loudness. Peak meters have an instant attack and slow decay and are useful in digital audio workflows where signal overload can cause immediate distortion. Volume Units (VU) meter ballistics correspond closely to how the human ear perceives loudness. VU meters provide good visual indication of how loud a signal will be, but provides poor information of actual signal peaks.

The MixPre II uses a combination Peak+VU ballistics for all meters, where the perceived loudness (or VU) is simultaneously displayed as a standard bar while the peak signal is displayed as a single, independent segment above the VU.

Channel Screen Meter



Main LR Stereo Meter View



LR, ISO Multi-Track Meter View (MixPre-10 II shown)

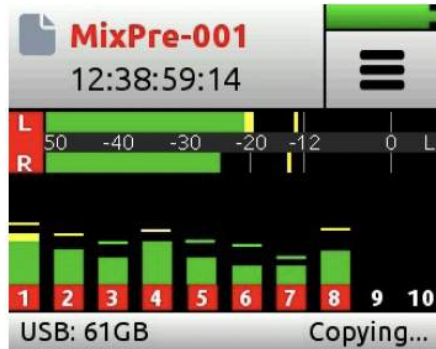

LR, Camera Returns, and USB 1,2 Meter View



Limiters

The MixPre II has fully adjustable limiter parameters giving control over Ratio, Release and Threshold. The limiters can be fine tuned for dialog, foley, nature recording, and even live instruments. Access the Limiters menu by navigating to Menu > System > Limiters.

The following options are available in the Limiters menu:

On/Off

Toggles the Limiters On or Off. While set to On the limiter is a global setting and applies to every channel.

Limiter Setup

Toggle limiter preset between Factory or Custom.

Custom

Enters Custom Limiter set up menu giving the following parameter adjustments:

Ratio

Sets the Limiting ratio. Options are Inf:1, 10:1, and 20:1. 20:1 is the default setting.

Release

Adjustable from 50-1000 ms in 10 ms increments. 100 ms is the default setting.

Threshold

Threshold is adjustable from -2 to -12 dBFS in 1 dB steps. -6 dBFS is the default setting. Any changes made in Custom Limiter mode are retained after leaving the menu, allowing you to compare the Factory setting and your own Custom Limiter setting.

Limiters are disabled in 32-bit float mode.

Outputs

The MixPre II features multiple Output configurations for flexible recording scenarios. The Outputs menu is available in Advanced mode. In the Outputs menu, you may send any channel, Aux input, USB input or LR mix to either the outputs, mute outputs, and control gain. The MixPre-3 II and MixPre-6 II Stereo Out can be configured to send audio, timecode, or split audio/timecode.

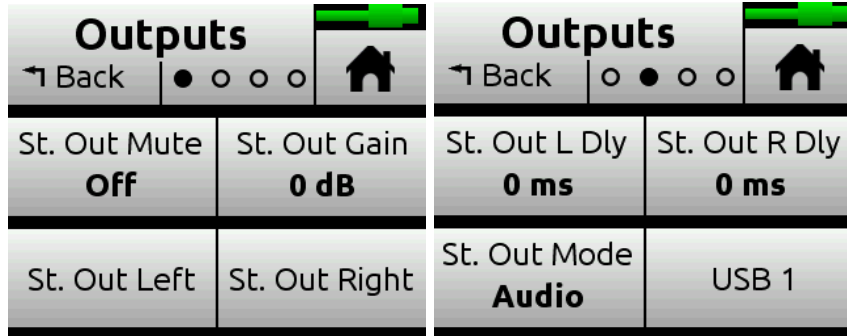

MixPre-3 II and MixPre-6 II

Stereo Out Mute

Mutes the output.

Stereo Out Gain

Adjusting output gains is useful for optimizing the level feeding downstream devices such as transmitters, external mixers, PA, etc. The level of the output can be set to Off, 40 to +20 dB in 1 dB steps. Not available when St. Out Mode is set to timecode.

Stereo Out Left Or Right

Configures output source, select from Mix L, Mix R, Isolated Channels (pre or post-fade), Aux In, or USB streaming into the MixPre II from a computer. Not available when St. Out Mode is set to timecode.

Left, Right Output Delay

Output delay is particularly useful when sending audio to video operators on a production set or in live streaming applications to ensure that audio is in sync with video. Outputs can be delayed from 0 to 400 ms. Delay applies to the Stereo Out left and right and any USB output routed from Out L or R.

Stereo Out Mode

Configures the output to be used as an LTC timecode, a stereo audio output, or a split audio/timecode output.

Stereo Out Left Or Right

Configures output source, select from Mix L, Mix R, Isolated Channels (pre or post-fade), Aux In, or USB streaming into the MixPre II from a computer.

USB 1-6 (MixPre-3 II)

Configures output source from L,R, 1-3 (pre- or post-fade), Headphone L, R, or Output L,R.

USB 1-6 (MixPre-3 II with +2ch plugin)

Configures output source from L,R, 1-5 (pre- or post-fade), Headphone L, R, or Output L,R.

USB 1-8 (MixPre-6 II)

Configures output source from L,R, 1-6 (pre- or post-fade), Headphone L, R, or Output L,R.

MixPre-10 II

L/R Out Mute

Mutes the output.

X1/X2 Out Mute

Mutes the output.

L/R Gain

Adjusting output gains is useful for optimizing the level feeding downstream devices such as transmitters, external mixers, PA, etc. The level of the output can be set to Off, 40 to +20 dB in 1 dB steps.

X1/X2 Gain

Adjusts the level of the output from Off, 40 to +20 dB in 1 dB steps.

Left Or Right Output

Configures output source, select from Mix L, Mix R, Isolated Channels (pre or post-fade), Aux In, or USB streaming into the MixPre II from a computer.

Left, Right, X1, X2 Output Delay

Output delay is particularly useful when sending audio to video operators on a production set or in live streaming applications to ensure that audio is in sync with video. Outputs can be delayed from 0 to 400 ms. Delay applies to the left, right, X1 and X2 outputs and any USB output routed from Out L, R, X1, or X2.

USB 1-12

Configures output source from L,R, 1-10 (pre- or post-fade, Headphone L, R, or Output L,R, X1,X2).

To Route The L/R and X1/X2 Stereo Outputs:

1. Tap .
2. Tap Outputs.
3. Select any of the following:
 - a. L Output
 - b. R Output
 - c. X1 Output
 - d. X2 Output
4. From the routing matrix, select what channel to send to the output.

In addition, if you choose to send the channels to outputs, you can select either pre-fade (Channel knob has no effect) or post-fade (Channel knob controls level).





Headphone Out

The MixPre II's high quality headphone amplifier provides high power and very low noise performance so that you can accurately hear the audio, regardless of headphones or environment.

Connect headphones via 3.5 mm jack to the headphone jack (located on the right side panel). The volume of the headphones is set using the knob directly adjacent to the headphone jack.

The headphone amplifier is capable of very high output levels. Please use caution when wearing headphones as hearing damage could result with inappropriate volume levels.

When clipping occurs in the headphones, the Headphone Clip indicator appears in the top right corner of screen, over the Power Status indicator.



Access The Headphone Preset Menu

1. Enter the main menu.
2. Tap  in the upper left hand corner.
3. Above this icon, the currently selected HP preset is displayed.

Advanced Mode - Creating A Custom HP Preset

Select Edit HP Preset (Advanced Mode Only) to edit and name any of the User HP Presets.

Advanced Mode - HP Solo

HP Solo mode provides options for single or multi-channel solo monitoring. Soloing channels is performed in the channel screens.

Disabling Record Bells In Headphones

Record bells, heard in headphones when recording is started and stopped, may be turned off. The record bells can be turned off in the Record menu.

Headphone Preset Options By Model

MixPre-3 II

Basic Mode: LR Stereo, USB 1, 2, Advanced Mode: LR Stereo, LR Mono, USB 1, 2, and User Presets 1-4
Camera options appear when Aux In is set to Camera.

MixPre-6 II

Basic Mode: LR Stereo, USB 1, 2, USB 3,4
Advanced Mode: LR Stereo, LR Mono, USB 1, 2, and User Presets 1-4
Camera options appear when Aux In is set to Camera.

MixPre-10 II

Basic Mode: LR Stereo, X1X2 Stereo, USB 1,2, USB 3,4, and User Presets 1-4.

Advanced Mode: LR Stereo, LR Mono, X1X2 Stereo, USB 1,2, USB 3,4, and User Presets 1-4.

Camera options appear when Aux In is set to Camera.

Tone

The built-in tone generator can be used to feed external devices to assist with gain staging. It's level can be adjusted from -20 to 0 dBFS. Two Tone Modes are available; Continuous or L-Ident, the latter being useful for identifying the left channel of a stereo signal.

MixPre-3 and MixPre-6 II: Tone is routed to the L and R tracks and Stereo Out. Tone is activated from the Tone menu.

MixPre-10 II: Tone can be routed to any combination of tracks and outputs. Tone is activated from the Tone/Slate menu.

Slate Mic (MixPre-10 only)

The built-in slate mic can be used for slating or for coms. It's level can be adjusted from 0 to 50 dB. Activate from the Tone/Slate menu or using the shortcut * or ** switch (when set accordingly - see Using Star Shortcuts). The slate mic can be routed to any combination of tracks and outputs.

Note: When the slate mic is turned on, Aux In 2 is temporarily disabled because it shares the same audio hardware path as the Slate Mic. When Slate Mic is then turned off, Aux In 2 is re-enabled automatically.

Using the MixPre II as a USB Audio Interface

The MixPre II Series perform as highly capable and pristine quality USB audio interfaces. They support up to 96 kHz sample rate at bit depths of 16, 24, 32-bit integer or 32-bit float. The MixPre II's 32-bit float USB audio path makes it possible to record into a DAW above 0 dBFS without clipping.

A list of compatible 32-bit float OS and DAW's can be found at www.sounddevices.com/32-bit-float-applications

For PC users, the MixPre II appears as a 2x2 audio interface unless a specific ASIO® driver is installed. The latest ASIO drivers are available for free at www.sounddevices.com/download

A PC running Windows 10 or higher is required to stream 32-bit float audio. A PC running Windows 7 or below will not stream audio at 32-bit float. Please install the correct ASIO driver relative to your operating system.

To work with the USB audio from a host computer, it is necessary to route the USB 1 - 4 sources appropriately. To mix the USB audio from the host computer with live audio from the inputs to the LR bus, use the channel screen and select input source. To hear the USB host computer audio in the headphones only, switch the HP preset to USB 1,2 or USB 3,4.

The MixPre II is capable of recording and streaming audio to a USB host simultaneously, or recording the USB audio stream out of a computer directly to its SD recorder.

When connected to a computer as a USB Audio Interface the sample rate of the MixPre II is determined by the computer.

Low-Latency Monitoring

Latency has been minimized while using the MixPre-II as a USB interface. In situations where the throughput latency is higher than desired, the input can be directly monitored in the headphone output.

To Monitor With Zero-Latency:

1. Connect via USB-C to the USB port on your computer.
2. Confirm that the LR Stereo HP Preset is selected.
3. Select USB 1 for Channel 1 source (MixPre-3 II), Channel 5 source (MixPre-6 II), or Channel 9 source (MixPre-10 II) and Pan L.
4. Select USB 2 for Channel 2 source (MixPre-3 II), Channel 6 source (MixPre-6 II), or Channel 10 source (MixPre-10 II) and Pan R.

OR

1. Create a custom HP preset that mixes the microphone or input you want to record from with the USB 1 and/or USB 2 feed from the computer. For example, HP L = Ch1 + U1 and HP R = Ch1 + U2.
2. Connect microphone or other inputs to remaining channels.
3. Select USB 1 for Channel 1 source (MixPre-3 II), Channel 5 source (MixPre-6 II), or Channel 9 source (MixPre-10 II) and Pan L.
4. Select USB 2 for Channel 2 source (MixPre-3 II), Channel 6 source (MixPre-6 II), or Channel 10 source (MixPre-10 II) and Pan R.
6. Connect microphone or other inputs to remaining channels.
7. Select the appropriate inputs for remaining channels.
8. Setup your DAW software for a new track with its source being any of the available channels.
9. Disable record monitoring or mute the channel's output in the DAW.

You should now be able to hear and adjust the output of your DAW audio through the channels you set to USB 1 and 2 on your MixPre while adjusting your low-latency feed in your headphones (and send levels to DAW) using the remaining channel knobs.

USB Output Routing

Each of the MixPre's USB audio output streams can be sourced from any channel (pre- or post-fade), LR mix bus, headphone output or LR output and X1,X2 (on the MixPre-10 II only).

Mix-Minus Sends

A mix-minus send is used when working with remote contributors in podcasting, conferencing and broadcast applications. It allows the remote contributor to hear the program mix, minus their own voice, the remove distracting latency.

To Setup Up A Mix-Minus Send:

1. In the Outputs>St.Out Left or St.Out Right menus (or L, R, X1, or X2 Output menus on the MixPre-10 II), create a summed mix of all the channels you want to send to the remote contributor minus their own channel. You can mix the channels pre-fade or post-fade.

2. Select the Output you have configured in step 1 as the source for the USB channel you are sending to the remote contributor.

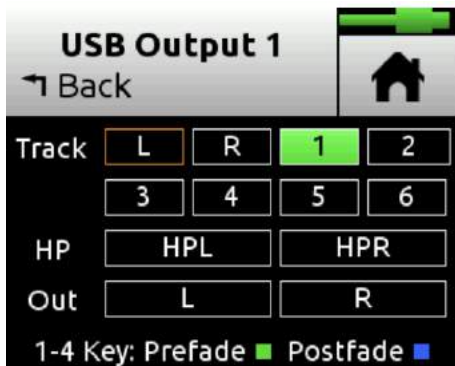
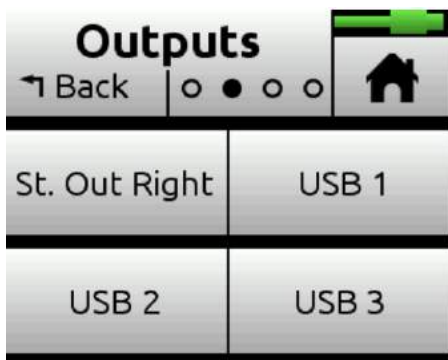

System

Mode

Switch between Basic, Advanced and Custom.

File Transfer

Transfer files between the MixPre and a host computer.

USB Audio

Switch between Normal or Stereo Out. The Stereo Out option allows you to set the USB Audio interface to output only 2 channels in order to increase compatibility with applications that do not support multichannel USB audio.

USB-C (MixPre-3 II and MixPre-6 II Only)

Switch between Power only or Audio when using with a USB-C power or audio source.

Limiters

Set limiters to off, factory, or custom.

Bluetooth

Switch Bluetooth on/off.

NOISEASSIST (Plugin Required)

Activate and setup NoiseAssist routing.

Wingman Password

Set a required password for the Wingman app.

Brightness

Adjust the brightness of the touch screen and the ring LEDs.

Date/Time

Set current date/time and format.

Tune Crystal (MixPre-10- II Only)

Fine tune the internal crystal frequency to an external word clock or LTC signal via BNC In.

Regulatory

Provides full Federal Communications Commission (FCC) compliance information.

Version

Provides the model type, current firmware version, and serial number.

Update Firmware

Update the firmware from a file on the SD card. The latest firmware can be downloaded from the Sound Devices website:

www.sounddevices.com/support/downloads

While updating firmware, power the MixPre via:

-USB-C on the MixPre-3, -3M, -3 II, MixPre-6, -6M, or -6 II

When powering via USB-C from a computer, it is best to set Menu>System>USB-C to Power Only.

Use the included Hirose power supply for the MixPre-10T, -10M, or -10 II.

Fully charged batteries are also acceptable on all models.

Do not perform the update with unstable power sources.

Firmware updating is prevented if battery level is low.

When upgrading to firmware version 7.0 or higher from any version lower than 6.0 the firmware installation process needs to be completed twice. After the first installation is complete, the MixPre II prompts you to start the second installation process.

Plugins

View and apply plugins. Plugins enhance the capability of your MixPre II and are available to purchase at

<https://store.sounddevices.com/>

Formatting Media

SD cards must be formatted by the MixPre II for reliable recording and playback. Back-up any wanted audio recordings or data on the SD card before formatting. The formatting process erases all data on the SD card.

If a USB thumbdrive is inserted into the USB A port, the MixPre II automatically copies the current project's recorded files to it. The thumbdrive must also be formatted before use.

We highly recommend using Sound Devices branded SD cards as these have been optimized to provide the best performance. If these are not available, most reputable manufacturers' cards (such as SanDisk or Delkin) that meet or exceed class 10 speeds are acceptable. Similarly, we highly recommend only using Sound Devices' approved USB thumbdrives to ensure reliable operation. Current approved media can be found [here](#).

All media will be formatted as exFAT. If any media is formatted differently, the MixPre will display a formatting reminder. The exFAT file system is not compatible with Windows XP or Mac OS X 10.6.4 and lower.

Format SD Card

1. Insert an SD card in the slot located on the rear panel.
2. Navigate to SD Card > Edit > Format.
3. When asked to confirm the command to format the card, touch OK.

Format USB Thumbdrive

1. Connect a USB ThumbDrive to the USB-A port located on the left panel or USB hub.
2. Navigate to USB Drive > Edit > Format.
3. Confirm the command to format the card, and touch OK.

USB Auto-Copy

The MixPre II will auto-copy to a formatted USB-A thumbdrive when inserted directly into the USB-A port or when using a USB hub. Stopping a recording will automatically copy the last recorded file to the thumbdrive. While copying, the record button on the MixPre-3 II and MixPre-6 II and the ring LED on the MixPre-10 II will flash while the process is being completed. The completion rate will display as a percentage on the bottom right corner of the status bar. If a new recording is started while auto-copying is still in progress, auto-copying will still continue.



Interrupting USB Auto Copy With Power Cycle

Auto-copy can be temporarily suspended during longer copying times.

During auto-copy in stop mode, pressing stop or toggling the power switch to OFF brings up the following popup:

"Suspend USB auto-copy? Copying will resume when record is next pressed. OK, Cancel"

If "OK" is pressed, Auto-copying is suspended and will resume copying when record is next pressed.

If "Cancel" is pressed, Auto-copying will continue until complete then power down if switch is off or sit in idle if power switch is on.

While the MixPre II is auto-copying, the USB Drive and SD Card menu are unavailable.

Record - Basic Mode

Pre-Roll Time

Pre-roll captures audio for a set amount of time before Record is pressed, ensuring important audio is never missed. Pre-roll time decreases as sample rate increases. Choose up to 10 seconds of pre-roll at 48 kHz. At 96 kHz pre-roll is limited to a maximum of five seconds, and two seconds at 192 kHz. Pre-roll is not available in record run mode or when using a record trigger.

REC Trigger

Sets record triggering from either timecode, HDMI flag or HDMI FUJIFILM flag. The default is Off.

Record Bells

Enable or disable record bell notifications. Record bells are On by default.

Record - Advanced Mode

REC L, R

Arms L and/or R mix buses. Choose between Off, Off & Linked, L, R, L&R, and L&R Linked.

L Gain

Sets the gain for the L mix

Right Gain

Set the gain for the R mix. This setting is disabled when Rec L,R Mix is set to LR Linked.

Sample Rate

Set the internal sample rate and sample rate of recorded WAV files. Choose between 44.1 kHz, 47.952 kHz, 48 kHz, 48.048 kHz, 96 kHz, and 192 kHz.

When Timecode Mode is set to HDMI TC In, the connected camera determines the sample rate of the MixPre II.

When using the MixPre II as a computer audio interface, the sample rate is determined by the computer.

BIT Depth

Select between 16, 24, and 32 float bit depth.

Pre-Roll Time

Pre-roll captures audio for a set amount of time before Record is pressed, ensuring important audio is never missed. Pre-roll time decreases as sample rate increases. Choose up to 10 seconds of pre-roll at 48 kHz. At 96 kHz pre-roll is limited to a maximum of five seconds, and two seconds at 192 kHz. Pre-roll is not available in record run mode or when using a record trigger.

REC Trigger

The MixPre II may be configured to begin recording when it is triggered. Setting the Record Trigger to HDMI flag will initiate record when a compatible device issues the record flag via the HDMI input. The MixPre II has two HDMI rec trigger options. HDMI flag for Sony, Panasonic, Nikon, Canon and Blackmagic cameras and HDMI FUJIFILM for FUJIFILM cameras. Setting the Record Trigger to Timecode will initiate record when the MixPre II detects running LTC timecode via the Aux or BNC inputs (MixPre-10 II only). Set record triggers in the Record Menu. When record triggers are used, Pre-roll is disabled.

Remix

Allows you to simultaneously play back a file and record a new L/R mix while adjusting the gains with the fader knobs. To remix a recording, turn on Remix in the Record menu. Select a file from the File List that has isolated tracks and select Remix.

Tip: Enable MixAssist with remixing/re-recording to help clean up audio and reduce background noise in an existing recording.

Left N.Asst (Plugin Required)

Sets the amount of NoiseAssist suppression on the L mix track. Adjust from 0 dB (no suppression) to -20 dB (maximum suppression) in 1 dB steps. Only available when L is selected in the System > NoiseAssist menu.

Right N.Asst (Plugin Required)

Sets the amount of NoiseAssist suppression on the R mix track. Adjust from 0 dB (no suppression) to -20 dB (maximum suppression) in 1 dB steps. Option is only available when R is selected in the System > NoiseAssist menu.

Record Bells

Enable or disable record bell notifications. Record bells are On by default.

File Splits

To conform to the Broadcast WAV File standard, the maximum size of a file recorded by the MixPre II is 4GB. If a recording exceeds this limit, the MixPre II will automatically begin recording a new file. The recording process is seamless, meaning the two files can be joined together in post with no loss in audio.

Timecode

When timecode is enabled, it is displayed on the home screen beneath the current filename. Standard timecode is displayed as HH:MM:SS:FF. Drop-frame timecode is displayed with a semicolon between the seconds and frames fields: HH:MM:SS;FF.

Each time you press record, the current timecode value is stored inside the Broadcast WAV file. Most popular video editing applications can read this timecode value to help sync the audio with picture.

When power is removed, the internal battery maintains accurate timecode for up to 4 hours. An alert will be issued whenever the timecode generator (in Free Run and Time of Day timecode modes) has reset due to internal battery depletion. This internal battery is automatically charged anytime the MixPre II is powered on.

TC Mode

Select between Free Run, Time of Day, Rec Run, BNC In (MixPre-10 II only), Aux In 1, Aux In 2, HDMI TC In, HDMI FUJIFILM or Off. When using Aux In 1 or 2 for Timecode, be sure to set Inputs>Aux In Mode to Timecode.

Frame Rate

Select between 23.98, 24, 25, 29.97nd, 29.97dF, 30, and 30 dF. Setting the frame rate is not necessary when using BNC, Aux, or HDMI In.



Jam

With the MixPre to Free Run and the frame rate set to the source's frame rate, tap Source and select BNC In or Aux TC. Tap Jam TC to jam timecode. Jamming is successful if Diff = 00:00:00:00.

Set TC

Manually set timecode.

BNC In

MixPre-10 II only. Set BNC to Timecode or Word Clock.

BNC Out

MixPre-10 II only. Set BNC to Timecode or Word Clock.

Note: The MixPre-3 II and -6 II can output timecode via their 3.5 mm Stereo Out connector. See Outputs > Stereo Out Mode.

Sync REF

MixPre-10 II only. Select from BNC In or Internal. When BNC In is selected, the MixPre-10 II can be set to sync to an external timecode or word clock sync reference connected to BNC In.

Set UBITS

Click "Mode" at top to edit UBits Mode. From the main screen, press in with the headphone encoder to modify the value of a UBit. Use the arrows or scroll with the encoder to select.

To maintain accurate timecode count over a power cycle, ensure MixPre is not connected as a USB audio interface to a computer during power up. It is best practice to rejam timecode devices after switching modes (Basic, Advanced or Custom) or after any setting change requiring a reboot (32-bit float, MixAssist, Music mode or Ambisonics).

Timecode Modes

Free Run

Timecode runs continuously. Timecode continues counting accurately for up to four hours after power-down.

REC Run

Timecode runs while recording and is stationary when not recording. In this mode, timecode defaults to the last stationary value at power-up. When switching to Record Run from another mode, the internal generator will stop at the last timecode value. Timecode output can be used to trigger other equipment that supports timecode remote triggering to start and stop recording.

Time Of Day (TOD)

Alternatively known as 24 hr run mode, this is similar to free run mode except that the timecode generator is automatically loaded with the time of day. Use TOD mode when you want the recorded WAV files to be timecode stamped with the time of day generated by the internal clock.

BNC In, AUX In 1, AUX In 2

Timecode can be derived from external timecode connected to the TC In BNC or to the tip or ring of the 3.5 mm Aux/Mic In connector.

HDMI TC In

Many DSLR-style cameras output timecode via HDMI.

If HDMI TC In is selected without an HDMI source connected, the MixPre II will report missing sync. The MixPre II has two HDMI timecode modes, HDMI flag for Sony, Panasonic, Nikon, Canon and Blackmagic cameras and HDMI FUJIFILM for FUJIFILM cameras.

LTC Timecode is not present on the MixPre-3 II and MixPre-6 II

Stereo Out or the MixPre-10 II BNC out when HDMI TC In is in use.

When set to HDMI TC In, the connected camera determines the sample rate of the MixPre II.

OFF

Setting TC Mode to Off disables the timecode feature. When Off, the time counter below the filename region on the home screen displays elapsed time instead of timecode.

Presets

If you plan to use the MixPre II in a wide variety of situations, you can store and recall snapshots of all of the MixPre II's settings. Setup files can be saved and recalled from the SD card or to one of four internal preset slots. You can also restore the MixPre II to the factory default settings from the Presets menu.

Load

Loads factory defaults or user presets from SD Card or from one of four internal slots.

Save to INT 1-4

Saves the current setup to internal slot 1, 2, 3, or 4.

Save to SD

Saves the current setup to the SD card.

Projects

New

Create a custom project name or project name based on the current date. Names may be up to 18 characters long.

Open

Select the required project. This will load the File List with the selected Project's files.

Copy

Select the project to copy to a USB-A Drive.

Trash Project

Select which project to trash. This moves the selected project and all its files to the TRASH folder. Projects in this folder are accessible using a computer. You can permanently delete projects in the SD card's TRASH folder using a computer or by formatting the card.

Create Report

The MixPre II includes the ability to create a .csv sound report file for the active project. It contains useful descriptive information about the project settings and all its recorded files. This can be used as a log of your recording session or as an electronic report that you can send along with your audio files to post-production or a client. The CSV sound report file is stored in the active project's folder alongside audio files and is named as follows: ActiveProjectName_Report.csv

Report Info

The MixPre II can customize the sound report's descriptive header information to include various project details, such as Producer, Director, Job, Name, Location, Phone, E-mail, Client, etc. Enter details for each info item using the on-screen virtual keyboard, a USB keyboard. If items are blank, they will not be included in the report file.

File List - Basic Mode

To Access The File List

1. Touch the filename at the top of the Home screen.
2. Scroll through the chronological list of all files in an active project with the headphone encoder. The top item in the list is the next file to be recorded. Directly below that is the last recorded file or file currently being recorded, followed by all previously recorded files.
3. Press Edit or push the headphone encoder in to access submenus for each file.

To Playback A File From The List

Scroll to a file and press Play to play it back.

Name

Edit the file's name.

Number

Edit the file's number. File numbers are reset to 001 when a new Project is created.

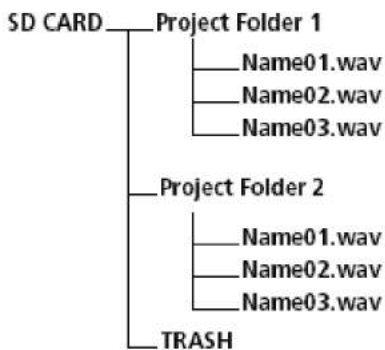

File List - Advanced Mode

To Access The File List

1. Touch the filename at the top of the Home screen.
2. Scroll through the chronological list of all files in an active project with the headphone encoder. The top item in the list is the next file to be recorded. Directly below that is the last recorded file or file currently being recorded, followed by all previously recorded files.
3. Press Edit or push the headphone encoder in to access submenus for each file.

To Playback A File From The List

Select a file and press Play to play it back.

Undo

Undo moves the last recorded file to the SD card's UNDO folder and resets the number of the next file. Files in this folder are accessible using a computer.

Name, Num, Notes

Edit the file's name, number, and, in advanced mode, make notes. File numbers are reset to 001 when a new Project is created.

Track Names

Edit track names within a file.

Rename

Rename the file's name and number.

Trash File

Deletes the file.

Cue List

Brings up list of all cue marks added during record or playback. Name, move, and delete cue marks on this list.

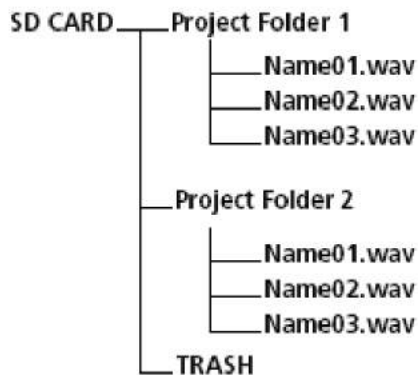

Cue Marks

Cue marks make it easy to quickly locate points of interest within a file. A maximum of 99 cues are allowed per file. Cues appear in numerical order in the Cue List.

Add A Cue Mark

1. During recording, playback, or pause, tap  to add a cue mark. The Q icon is found at the top of the Home screen. A cue mark number (starting from 01 and incrementing each time a new cue mark is added) is displayed next to the Q icon.
2. The MixPre automatically renumbers cue marks when inserted between existing cue marks. This maintains the cue markers ascending numerical order from start to finish—01, 02, 03, etc.

Access The Cue List

1. Tap .
2. Use the Headphone knob to select a file (or highlight a file and tap Edit).
3. Tap Cue List from the Edit menu.
4. Cues may be played, named, moved, or deleted.



Playback From A Cue Mark

1. From the Cue List, use the Headphone knob to highlight a cue.
2. Press Play.

Name A Cue Mark

1. From the Cue List, use the Headphone knob to select a cue mark.
2. Tap Name.
3. Enter a new name then tap Ok.



Move A Cue Mark

You can finely tune the position of cue marks in 0.1 second increments.

1. From the Cue List, use the Headphone knob to select a cue mark.
2. Tap Move

3. Turn the Headphone knob to adjust the selection in 0.1 second increments.
4. Press the Headphone knob to save the new cue position.

Delete A Cue Mark

1. From the Cue List, use the Headphone knob to select a cue mark.
2. Tap Delete.

Using Star Shortcuts (*/**)

MixPre-6 II

For your convenience, we have included a front panel programmable button. This lets you dedicate a hardware shortcut to frequently used functions without having to navigate the menus. Program the * button in the *Button menu.

MixPre-10 II

For your convenience, we have included a two-position programmable toggle switch on the front panel. This lets you dedicate hardware shortcuts to frequently used functions. Program the * and ** switch in the *Shortcuts menu.

PROGRAMMABLE FUNCTIONS

1. Ch 5/6 Screen Toggle (MixPre-6 II)
2. Ch 9/10 Screen (MixPre-10 II)
3. Solo/Mute screen
4. Project screen
5. SD Card screen
6. Undo
7. Slate Mic
8. Tone
9. Q
10. St Out Mute (MixPre-6 II)
11. L/R Mute (MixPre-10 II)
12. X1/X2 Mute (MixPre-10 II)

Wingman Application



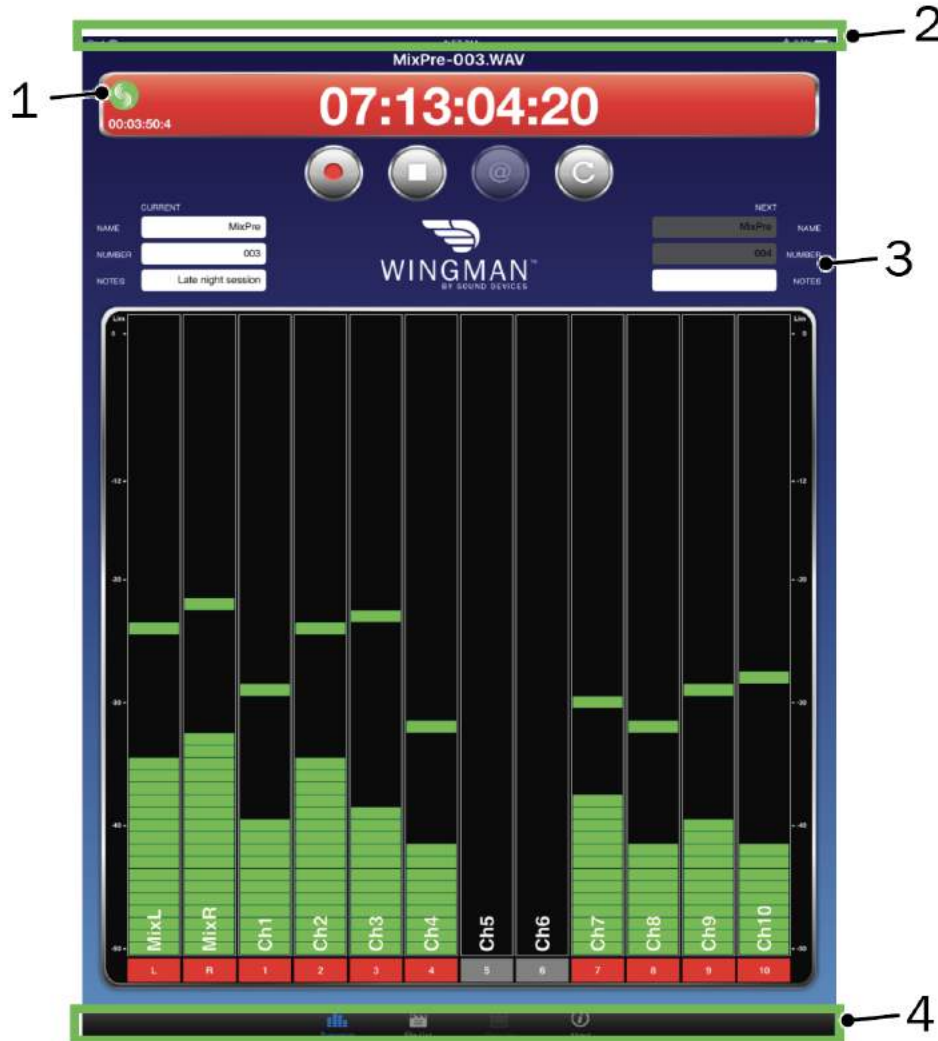

Sound Devices Wingman is a free app that allows wireless remote control of the Bluetooth Smart-enabled MixPre Series from iOS or Android devices.



1: Connection Icon

Tap the Connection icon to efficiently switch connection from one device to another from within the app. Tapping the Circled-I icon helps identify a listed MixPre by displaying an “Identifying from Wingman” message on the chosen recorder’s screen.

Connection Icon Status Colors

Gray		Disconnected - either no activity or scanning for devices
Orange		Bluetooth connection in progress
Yellow		Connected - authentication underway
Green		Connected and authenticated

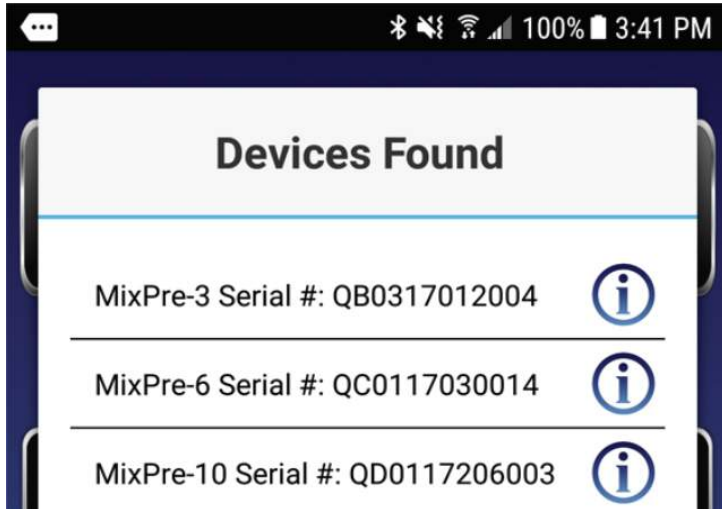

2: Status Bar

3: Viewing Area

On smaller devices, the viewing area displays transport and track views. Swipe horizontally to toggle between views. On larger devices, the viewing area shows only transport view.

4: Tab Bar

Transport View

Displays control buttons, metadata fields, and meters. Swiping vertically toggles to other meters. On larger devices, arming and naming of tracks is done in transport view.



Transport View

Track View

On smaller devices, arming and naming of tracks is done in track view.



Track View

Renaming Tracks

1. On large mobile devices, from the Transport view, tap anywhere in a vertical meter for the track you want to edit.
2. On small mobile devices, swipe horizontally to display the Track view, then tap anywhere in a horizontal meter for the track you want to edit.
3. Use the virtual on-screen keyboard to modify the track name.
4. Tap Done when finished to save the changes.
5. Tap anywhere on screen other than the keyboard to exit without saving changes.

Arming/Disarming Tracks

1. Tap the meter label. When armed the label turns red. When on but disarmed, the label is gray. When the input is off, the label is black and cannot be armed.
2. Meter labels are joined (displayed as a single label) to indicate when channels are linked.

ENABLE BLUETOOTH ON THE MIXPRE

This toggles Bluetooth On and Off. If a remote password is configured on the recorder in the System>Wingman Password menu, Wingman will prompt for that password to be entered prior to making the connection.

Set And Clear The Wingman Password

For added security, set up the MixPre recorder to require a password for remote access. Use the virtual keyboard or a USB keyboard to enter a password up to 18 alpha-numeric characters . Punctuation other than a hyphen or an underscore is not permitted.

File List Tab

MixPre files and their embedded BWF/iXML metadata can be viewed and edited in the File List tab.

Sound Report

Sound reports can be created and sent direct from Wingman as CSV files.

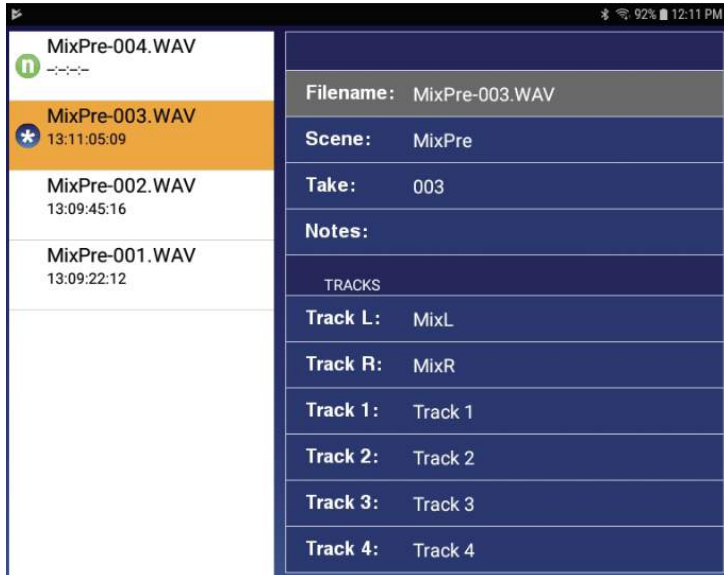

USB Hub

The MixPre II supports multiple USB devices such as USB thumb drives, Midi controllers, and/or USB Keyboards via a USB hub. To maximize USB hub support, note:

Powered hubs are recommended as these can deliver appropriate current.

If using non-powered hubs, do not connect more than three low power devices.

Connect each USB device individually rather than all at once.

The peak current of all three devices at once may exceed the max peak current of the supply.

If devices are randomly dismounting there is not enough current to power all the attached devices. Remove one or more devices or use a powered hub.

USB-A support (with or without hub) is only available when MixPre is fully powered and not in low power mode.

Only one USB controller can be used at a time.

Only one USB drive can be used at a time.

When using non-powered hubs with the MixPre 3 II or 6 II, use an L-mount battery, a 4-pin Hirose DC adapter (e.g. from Hawkwoods), a USB-C wall adapter, or USB-C battery pack (e.g. from Anker or Ravpower). USB-C from a computer may not provide sufficient power to operate all USB devices connected to a non-powered USB hub.

The USB-A port does not support hubs when being powered from AA batteries.

Use a high quality USB-C to C cable when powering from a USB-C power source, preferably one meter or less. Low quality USB-C cables could cause erratic behavior.

USB Keyboard

A connected USB keyboard may be used as a wired remote control for certain functions. Holding a keyboard function for longer than 0.5 seconds will repeat the shortcut action.

Keystroke	Description
Escape	Back. Also cancels out of editing mode when virtual keyboard is on screen
F1 or Menu key	Accesses the Main menu
F12	Home
F2	File list
F3	Cycles between available Meters views and the Main screen
Ctrl + R	Record
Ctrl + S	Stop
Spacebar	Play
Left Arrow	Main screen: Rewind Menu and Channel screens: Toggles through pages
Right Arrow	Main screen: Fast forward Menu and Channel screens: Toggles through pages
Up / Down Arrows	Main screen: Adjusts headphone volume In menus: Duplicates encoder rotation, such as moves highlight, scrolls list While editing parameters: Changes the value
Enter	In menus: Activates current selection. (Same as encoder press.) Also, same as choosing OK when virtual keyboard is on screen
Q	In menus: select top left option in quad button view
W	In menus: select top right option in quad button view MixPre-10 II: Top Center
A	In menus: select bottom left option in quad button view
S	In menus: select bottom right option in quad button view MixPre-10 II: Bottom Center
E	MixPre-10 II menus: Top Right
D	MixPre-10 II menus: Bottom Right
1-0	Channel screen for 1-10
*	Toggles assigned * Shortcut Action
Ctrl + M	Add cue mark
Ctrl + F	File transfer mode
Ctrl + 1-0	Toggle Arm status of Channels 1-10
Option + 1-0	Solo Channels 1-10
Ctrl + Option + 1-0	Mute Channels 1-10
1 + 2 + 3	Front Panel Lock Menu

X-Keys® Programmable Keypads, Sticks & Keyboards

X-Keys include a variety of compact, tactile input devices that can be programmed to emulate USB keyboard commands. Their various buttons and tactile controls are programmed via P.I. Engineering's MacroWorks Windows software. When mapped as individual commands or as macro commands to MixPre's USB Keyboard shortcuts listed above, they offer quick-access to many MixPre functions including Record, Stop, Play, and many more.

To use with MixPre, the X-Keys device must be connected to the MixPre's USB-A port.

Please visit P.I. Engineering's website for more information.

USB Controllers

The MixPre II Series can be connected to select third party controllers for tactile control of mixing and recording. These control surfaces provide a varied range of physical sliders, pots, and buttons to set fader levels, trim gains, pans, reverb sends, solos, mutes, record arming, transport control and more. Functionality varies depending on controller model. When connected to the MixPre II, some functions are taken over by the controller and are therefore disabled on the MixPre II.

Compatible Recorders

1. Korg NanoKontrol Studio
2. Korg NanoKontrol 2
3. Novation LaunchControl XL
4. AKAI MidiMix

Connecting The Mixpre To A Controller

Power and control is provided via a single USB cable to better facilitate simple connection between the MixPre and controller. For the MixPre-3 II and -6 II, USB Controllers will only function if the MixPre is adequately powered.

1. The MixPre may be powered on before USB connection or may be turned on after USB connection.
2. Connect one end of a USB cable to the MixPre's USB-A port and the other end to the controller's USB port, which can be a USB-B, Micro USB, or Mini USB port, depending on the controller model. We recommend using the USB cable supplied with the controller.
3. A popup screen displays the controller model. After a few seconds of configuration, the popup closes and the controller is ready to use.

Map User-Definable Buttons To Functions

1. Connect a controller.
2. On the MixPre, access Menu > * Shortcuts > Control Surface
3. Set any of the user-definable shortcut buttons to the assignable functions listed below.

Assignable Functions

1. Tone
2. L/R Mute
3. X1/X2 Mute
4. Undo
5. Slate Mic
6. Add Q
7. Record
8. Stop
9. Play
10. Rewind
11. Fast Fwd
12. Shuttle (not all controllers)



AKAI MidiMix



Korg NanoKontrol 2



Korg NanoKontrol Studio



Novation LaunchControl XL

Akai MidiMix Interface Functions

Function	Action
Fader Bank Switching	--
User-Definable Shortcut Buttons	Solo + Bank Left Solo + Bank Right
Record	via user-definable shortcut
PLAY	via user-definable shortcut
STOP	via user-definable shortcut
FFWD X2, X16	via user-definable shortcut
RWD X2, X16	via user-definable shortcut
Skip Next File	via user-definable shortcut (Tap Fast Forward)
Skip Prev File	via user-definable shortcut (Tap Rewind)
Skip Next Mark	via user-definable shortcut (Fast Forward)
Skip Prev Mark	via user-definable shortcut (Rewind)
Return to Zero	via user-definable shortcut (Stop)
Shuttle	Only via MixPre
Record Arm	REC Arm button
Record Arm Status	Red REC Arm button when armed
Input Monitor	--
Input Monitor Status	--
Channel Screen Access	Solo + REC Arm buttons
Faders	Linear faders 1-8
Trims	Top row knobs
Pans	Bottom row knobs
Reverb	--
Low Cut	Middle row knobs
Mute	Mute button
Solo	Solo + Mute buttons
Mute Status	Yellow Mute button
Solo Status	Yellow Mute button when Solo is pressed
L/R (Stereo) Output Gain	Master fader
L/R (Stereo) Output Mute	via user-definable shortcut
X1/X2 Mute (10 II only)	via user-definable shortcut
Tone	via user-definable shortcut
Metronome	--
Create Q	via user-definable shortcut
Undo	via user-definable shortcut
Internal Mic (10 II only)	via user-definable shortcut
SEND ALL Button	Sends all current fader, knob settings to MixPre

Korg NanoKontrol 2 Interface Functions

Function	Action
Fader Bank Switching	--
User-Definable Shortcut Buttons	Cycle + Marker Set Cycle + Marker < Cycle + Marker > Cycle + << Cycle + >>
Record	Record button
PLAY	Play button
STOP	Stop button
FFWD X2, X16	Hold >> button
RWD X2, X16	Hold << button
Skip Next File	Tap >> button
Skip Prev File	Tap << button
Skip Next Mark	Tap >> button
Skip Prev Mark	Tap << button
Return to Zero	Tap Stop
Shuttle	Only via MixPre
Record Arm	R button
Record Arm Status	Red R button when armed
Input Monitor	--
Input Monitor Status	--
Channel Screen Access	Cycle + S button
Faders	Linear faders 1-8
Trims	Rotary knobs (set to trim)
Pans	Rotary knobs (set to pan)
Reverb	--
Low Cut	Rotary knobs (set to low-cut)
Mute	M button
Solo	S button
Mute Status	Red M button
Solo Status	Red S button
L/R (Stereo) Output Gain	Only via MixPre
L/R (Stereo) Output Mute	via user-definable shortcut
X1/X2 Mute (10 II only)	via user-definable shortcut
Tone	via user-definable shortcut
Metronome	--
Create Q	Marker Set button
Undo	via user-definable shortcut
Internal Mic (10 II only)	via user-definable shortcut

Korg NanoKontrol Studio Interface Functions

Function	Action
Fader Bank Switching	--
User-Definable Shortcut Buttons	Cycle + Marker Set Cycle + Marker < Cycle + Marker > Cycle + << Cycle + >>
Record	Record button
PLAY	Play button
STOP	Stop button
FFWD X2, X16	Hold >> button
RWD X2, X16	Hold << button
Skip Next File	Tap >> or Marker >button
Skip Prev File	Tap << or Marker < button
Skip Next Mark	Tap >> or Marker >button
Skip Prev Mark	Tap << or Marker < button
Return to Zero	Tap < or Stop
Shuttle	Press MixPre HP encoder or set Shuttle as a shortcut, then use selected shortcut and scrub wheel.
Record Arm	REC Arm button
Record Arm Status	White REC Arm button when armed
Input Monitor	--
Input Monitor Status	--
Channel Screen Access	Select button
Faders	Linear faders 1-8
Trims	Scene 1 then use knobs
Pans	Scene 3 then use knobs
Reverb	--
Low Cut	Scene 2 then use knobs
Mute	Mute button
Solo	Solo button
Mute Status	White Mute button
Solo Status	White Solo button
L/R (Stereo) Output Gain	Only via MixPre
L/R (Stereo) Output Mute	via user-definable shortcut
X1/X2 Mute (10 II only)	via user-definable shortcut
Tone	via user-definable shortcut
Metronome	--
Create Q	Marker Set button
Undo	via user-definable shortcut
Internal Mic (10 II only)	via user-definable shortcut

Novation LaunchControl XL Interface Functions

Function	Action
Fader Bank Switching	--
User-Definable Shortcut Buttons	UP DOWN Device + UP Device + Down Device + Left Device + Right
Record	via user-definable shortcut
PLAY	via user-definable shortcut
STOP	via user-definable shortcut
FFWD X2, X16	via user-definable shortcut
RWD X2, X16	via user-definable shortcut
Skip Next File	via user-definable shortcut
Skip Prev File	via user-definable shortcut
Skip Next Mark	via user-definable shortcut
Skip Prev Mark	via user-definable shortcut
Return to Zero	via user-definable shortcut (Stop)
Shuttle	Only via MixPre
Record Arm	Select Record Arm, then Track Control button
Record Arm Status	Red Track Control button when Record Arm is selected
Input Monitor	--
Input Monitor Status	--
Channel Screen Access	Track Focus buttons
Faders	Linear faders 1-8
Trims	Top row of knobs
Pans	Bottom row of knobs
Reverb	--
Low Cut	Middle row of knobs
Mute	Select Mute, then Track Control button
Solo	Select Solo, then Track Control button
Mute Status	Red Track Control button when Mute is selected
Solo Status	Flashing Track Control button when Solo is selected
L/R (Stereo) Output Gain	Only via MixPre
L/R (Stereo) Output Mute	via user-definable shortcut
X1/X2 Mute (10 II only)	via user-definable shortcut
Tone	via user-definable shortcut
Metronome	--
Create Q	via user-definable shortcut
Undo	via user-definable shortcut
Internal Mic (10 II only)	via user-definable shortcut

Mounting to a Camera or Tripod

All MixPre II Series recorders have ¼-inch, 20-threaded screw mounts on their top and bottom panels for mounting to gear.

To attach your MixPre II between a camera and tripod:

1. Remove the battery sled to gain access to the back panel.
2. Retrieve the anti-rotation pin and Allen wrench. Both are magnetically held in place in the back panel.
3. From the MixPre II's bottom panel, insert the Allen wrench into the mounting screw hole and push up to reveal the retractable screw. Rotate
5. to screw the MixPre II into place underneath the camera.
6. Align the mounting screw hole on the bottom panel of the MixPre II with the screw on the tripod plate. Rotate the screw on the tripod plate until the MixPre II is affixed.

If your camera has a slot for the anti-rotation pin, screw the pin into place on top of the MixPre II, and then position the MixPre II against the bottom of the camera so that the pin fits into the camera's slot. The anti-rotation pin may also be screwed into a tripod and slotted into the bottom of the MixPre II.

1: Allen Wrench

2: Anti Rotation Pin

3: Threaded Hole for Anti-Rotation Pin

4: Retractable Screw

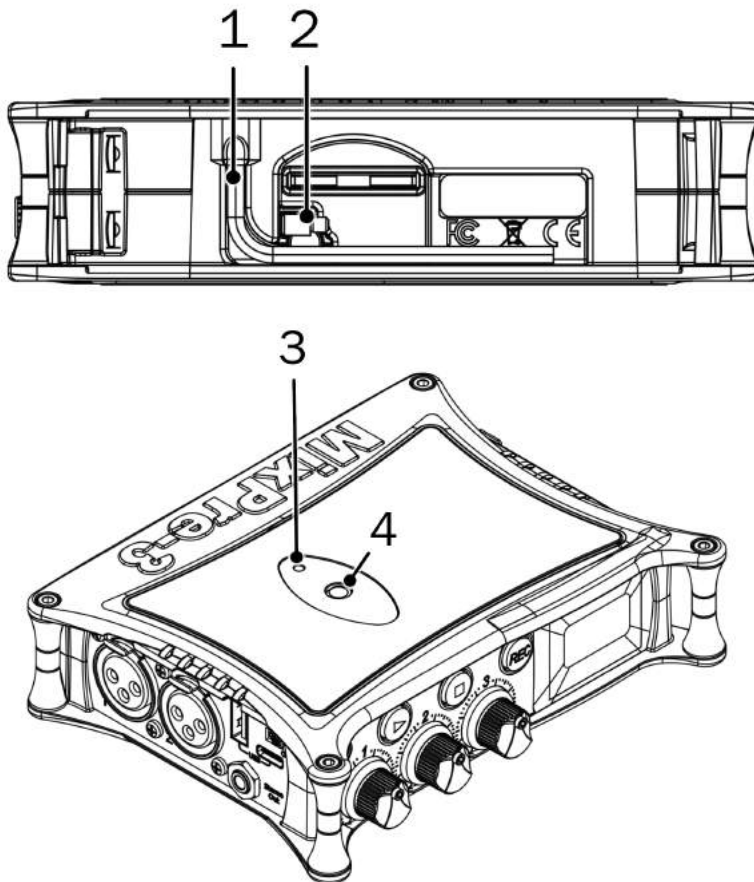

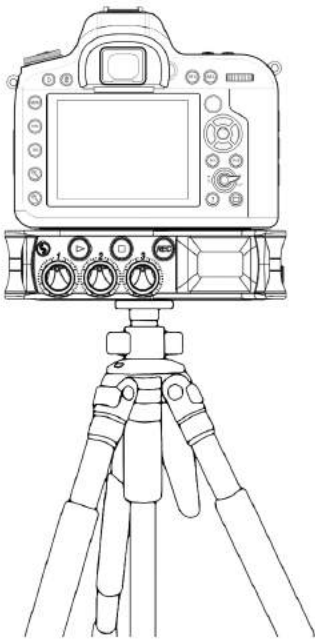

MixPre-3 II Specifications

Specifications are subject to change without prior notice.

For the latest information available on all Sound Devices products, visit our website: www.sounddevices.com.

Frequency Response

10 Hz to 80 kHz +/- 0.5 dB re 1 kHz @ 192 kHz sample rate

THD + Noise

0.005% max (@1 kHz, 22-22 kHz BW, gain= 20 dB, -10 dBu in)

ADC*

32 bit precision; 142 dB dynamic range min (A weighted, gain = 10 dB, fader = 0 dB)

Equivalent Input Noise

-130 dBV (-128 dBu) max (A-weighting, gain = 76 dB, 150 ohm source impedance)

Inputs

Mic: XLR active-balanced; 4k input

Line: XLR active-balanced; 4k input

Aux/Mic in: 3.5 mm TRS, 2-channel unbalanced; 2.2k

USB Audio: 2 channels

5 Total analog inputs: 3 mic-line inputs, 2 on Aux In

All inputs fully RF-filtered and overload protected

Gain

Mic input: +6 dB to +76 dB

Line input: -20 dB to +30 dB

Fader: -inf to +20 dB

Headphone: -inf to +20 dB

Total, Mic-to-recording (max): +96 dB

Aux In (Mic): Gain = +10 dB to +40 dB

Aux In (Line): Gain = -10 dB to +20 dB

Total Aux Gain including Fader (Mic-to-recording): +60 dB

Maximum Input Level

Mic XLR: +14 dBu (limiters on or off)

Line XLR/¼-inch: +28 dBu (limiters on or off)

Aux In (Mic): -10 dBu

Aux In (Line): +10 dBu

Low-Cut Filters

40 Hz to 160 Hz (adjustable), 18 dB/oct. First stage analog, subsequent stages digital

Limiters (16- and 24-bit operation only)

Limiter at all gain stages, range > 40 dB

First stage analog, subsequent stages digital

Adjustable threshold, ratio, and release

Microphone Powering

Mic XLRs: 48 V via 6.8k resistors, 10 mA each

Mic 3.5 mm: 3 V @ 3k source

Outputs

3.5 mm TRS stereo unbalanced, 500 ohm output impedance, +7.8 dBu max output level

Headphone Outputs

3.5 mm TRS stereo unbalanced, 300 mW + 300 mW, for use with any impedance headphones

DAC Feeding Stereo Out, Headphone Out

32 bit precision; 115 dB dynamic range (A-weighted)

USB

Audio Interface (USB-C): 6-in/2-out (from computer); 44.1 kHz/48 kHz/96 kHz; 16/24/32-bit integer, 32-bit float; Class-compliant USB 2.0 high speed driver

Mass Storage (USB-C): USB 2.0 high speed

Keyboard, X-Keys (USB-A): Text entry and control

Thumbdrive (USB-A): Manual or auto-copy to drive

Midi Control Surface (USB-A)

USB Hub

Recording

5 Tracks: stereo mix + 3 ISO's. Can be expanded to 7 tracks with the optional +2ch plugin.

44.1 kHz, 47.952 kHz, 48 kHz, 48.048 kHz, 96 kHz, 192 kHz sampling frequencies

16, 24, 32 float bit depths

Polyphonic WAV

Recording Storage

Type: SD, SDXC, SDHC Card, & USB thumbdrive (copy only)

Max Storage Size: 512 GB (SDXC)

Card format: exFAT

File Delivery to Cloud

Compatible with Viviana Cloud

Timecode

Modes: Free Run, Time of Day (file stamped w/current ToD), Rec Run, Ext LTC (file stamped w/incoming LTC on 3.5mm Aux In),

Camera TC (file stamped w/incoming TC from cameras that output TC)

Frame Rates: auto-detects (fps): 23.98 (same as 23.976), 24, 25, 29.97DF, 29.97ND, 30, 30DF

3.5 mm Aux In Timecode Input: 20k ohm impedance, 0.3 V - 3.0 V p-p (-17 dBu - +3 dBu)

3.5 mm Stereo Out Timecode Output: 1k ohm impedance, 3.0V p-p (+12 dBu)

TC Reader via HDMI

Power

AA Batteries: 4x AA sled (included); 8x AA sled (optional accessory). Energizer Ultimate Lithium recommended

L-Mount: Optional sled for 2x (hot-swappable) Li-ion batteries

From computer: Bus-powered via USB-C port optional MX-USBY cable, connects one USB-C to two USB-A ports

AC Adapter: MX-PSU (included) Power supply wall adapter w/ USB-C connector; 15 W; has 4 adapter plugs for US, UK, AU & Europe

Remote Control

Bluetooth LE: Wireless control using Wingman app

HDMI (micro): Auto-record start/stop trigger from cameras with output record flag over HDMI

Timecode: Auto-record start/stop trigger via Aux In timecode

Environmental

Operating: -20°C to 60°C, 0 to 90% relative humidity; (non-condensing)

Storage: -40°C to 85°C

Dimensions and Weight

36 mm x 144 mm x 110 mm (H x W x D); 1.40" x 5.68" x 4.35"

Weight: .48 kg; 16.8 oz. (unpackaged, without batteries)

Touch Screen: 320x256; 1.6-inch, color, sunlight-viewable IPS LCD

*patents #US9654134B2 (USA), #CA2973142C (Canada), and #EP3259845 (Europe)

MixPre-6 II Specifications

Specifications are subject to change without prior notice.

For the latest information available on all Sound Devices products, visit our website: www.sounddevices.com.

Frequency Response

10 Hz to 80 kHz +/- 0.5 dB re 1 kHz @ 192 kHz sample rate

THD + Noise

0.005% max (@1 kHz, 22-22 kHz BW, gain= 20 dB, -10 dBu in)

ADC*

32 bit precision; 142 dB dynamic range min (A weighted, gain = 10 dB, fader = 0 dB)

Equivalent Input Noise

-130 dBV (-128 dBu) max (A-weighting, gain = 76 dB, 150 ohm source impedance)

Inputs

Mic: XLR active-balanced; 4k input

Line: XLR active-balanced; 4k input

Aux/Mic in: 3.5 mm TRS, 2-channel unbalanced; 2.2k

Line: 1/4-inch TRS active-balanced; 4k input

USB Audio: 4 channels

6 Total analog inputs: 4 mic-line inputs, 2 on Aux In

All inputs fully RF-filtered and overload protected

Gain

Mic input: +6 dB to +76 dB

Line input: -20 dB to +30 dB

Fader: -inf to +20 dB

Headphone: -inf to +20 dB

Total, Mic-to-recording (max): +96 dB

Aux In (Mic): Gain = +10 dB to +40 dB

Aux In (Line): Gain = -10 dB to +20 dB

Total Aux Gain including Fader (Mic-to-recording): +60 dB

Maximum Input Level

Mic XLR: +14 dBu (limiters on or off)

Line XLR/1/4-inch: +28 dBu (limiters on or off)

Aux In (Mic): -10 dBu

Aux In (Line): +10 dBu

Low-Cut Filters

40 Hz to 160 Hz (adjustable), 18 dB/oct. First stage analog, subsequent stages digital

Limiters (16- and 24-bit operation only)

Limiter at all gain stages, range > 40 dB

First stage analog, subsequent stages digital

Adjustable threshold, ratio, and release

Microphone Powering

Mic XLRs: 48 V via 6.8k resistors, 10 mA each

Mic 3.5 mm: 3 V @ 3k source

Outputs

3.5 mm TRS stereo unbalanced, 500 ohm output impedance, +7.8 dBu max output level

Headphone Outputs

3.5 mm TRS stereo unbalanced, 300 mW + 300 mW, for use with any impedance headphones

DAC Feeding Stereo Out, Headphone Out

32 bit precision; 115 dB dynamic range (A-weighted)

USB

Audio Interface (USB-C): 8-in/4-out; 44.1 to 96 kHz; 16/24/32-bit integer, 32-bit float; Class-compliant USB 2.0 high speed or ASIO® (supplied via download)

Mass Storage (USB-C): USB 2.0 high speed

Keyboard, X-Keys (USB-A): Text entry and control

Thumbdrive (USB-A): Manual or auto-copy to drive

Midi Control Surface (USB-A)

USB Hub

Recording

8 Tracks: stereo mix + 6 ISOs

44.1 kHz, 47.952 kHz, 48 kHz, 48.048 kHz, 96 kHz, 192 kHz sampling frequencies

16, 24, 32 float bit depths

Polyphonic WAV

Recording Storage

Type: SD, SDXC, SDHC Card, & USB thumbdrive (copy only)

Max Storage Size: 512 GB (SDXC)

Card format: exFAT

File Delivery to Cloud

Compatible with Viviana Cloud

Timecode

Modes: Free Run, Time of Day (file stamped w/current ToD), Rec Run, Ext LTC (file stamped w/incoming LTC on 3.5mm Aux In), Camera TC (file stamped w/incoming TC from cameras that output TC)

Frame Rates: auto-detects (fps): 23.98 (same as 23.976), 24, 25, 29.97DF, 29.97ND, 30, 30DF

3.5 mm Aux In Timecode Input: 20k ohm impedance, 0.3 V - 3.0 V p-p (-17 dBu - +3 dBu)

3.5 mm Stereo Out Timecode Output: 1k ohm impedance, 3.0V p-p (+12 dBu)

TC Reader via HDMI

Power

AA Batteries: 4x AA sled (included); 8x AA sled (optional accessory). Energizer Ultimate Lithium recommended

L-Mount: Optional sled for 2x (hot-swappable) Li-ion batteries

From computer: Bus-powered via USB-C port: optional MX-USBY cable, connects one USB-C to two USB-A ports

AC Adapter: MX-PSU (included) Power supply wall adapter w/ USB-C connector; 15 W; has 4 adapter plugs for US, UK, AU & Europe

Remote Control

Bluetooth LE: Wireless control using Wingman app

HDMI (micro): Auto-record start/stop trigger from cameras with output record flag over HDMI

Timecode: Auto-record start/stop trigger via Aux In timecode

Environmental

Operating: -20°C to 60°C, 0 to 90% relative humidity; (non-condensing)

Storage: -40°C to 85°C

Dimensions and Weight

36mm x 166 mm x 118 mm (H x W x D); 1.40" x 6.53" x 4.65"

Weight: .56 kg; 19.9 oz. (unpackaged, without batteries)

Touch Screen: 320x256; 1.6-inch, color, sunlight-viewable IPS LCD

*patents #US9654134B2 (USA), #CA2973142C (Canada), and #EP3259845 (Europe)

MixPre-10 II Specifications

Specifications are subject to change without prior notice.

For the latest information available on all Sound Devices products, visit our website: www.sounddevices.com.

Frequency Response

10 Hz to 80 kHz +/- 0.5 dB re 1 kHz @ 192 kHz sample rate

THD + Noise

0.005% max (@1 kHz, 22-22 kHz BW, gain= 20 dB, -10 dBu in)

ADC*

32 bit precision; 142 dB dynamic range min (A weighted, gain = 10 dB, fader = 0 dB)

Equivalent Input Noise

-130 dBV (-128 dBu) max (A-weighting, gain = 76 dB, 150 ohm source impedance)

Inputs

Mic: XLR active-balanced; 4k input

Line: XLR active-balanced; 4k input

Aux/Mic in: 3.5 mm TRS, 2-channel unbalanced; 2.2k

Line: ¼-inch TRS active-balanced; 4k input

USB Audio: 4 channels

Built-in Slate Mic

10 Total analog inputs: 8 mic-line inputs, 2 on Aux In

All inputs fully RF-filtered and overload protected

Gain

Mic input: +6 dB to +76 dB

Line input: -20 dB to +30 dB

Fader: -inf to +20 dB

Headphone: -inf to +20 dB

Total, Mic-to-recording (max): +96 dB

Aux In (Mic): Gain = +10 dB to +40 dB

Aux In (Line): Gain = -10 dB to +20 dB

Total Aux Gain including Fader (Mic-to-recording): +60 dB

Built-in Slate Mic: 0 dB to 50 dB

Maximum Input Level

Mic XLR: +14 dBu (limiters on or off)

Line XLR/¼-inch: +28 dBu (limiters on or off)

Aux In (Mic): -10 dBu

Aux In (Line): +10 dBu

Low-Cut Filters

40 Hz to 160 Hz (adjustable), 18 dB/oct. First stage analog, subsequent stages digital

Limiters (16- and 24-bit operation only)

Limiter at all gain stages, range > 40 dB

First stage analog, subsequent stages digital

Adjustable threshold, ratio, and release

Microphone Powering

Mic XLRs: 48 V via 6.8k resistors, 10 mA each

Mic 3.5 mm: 3 V @ 3k source

Outputs

L/R: TA3 2-channel balanced, 1.1K max output impedance, +18 dBu max output level

X1/X2: 3.5 mm TRS stereo unbalanced, 500 ohm output impedance, +7.8 dBu max output level

Headphone Outputs

3.5 mm TRS stereo unbalanced, 300 mW + 300 mW, for use with any impedance headphones

DAC Feeding Stereo Out, Headphone Out

32 bit precision; 115 dB dynamic range (A-weighted)

USB

Audio Interface (USB-C): 12-in/4-out; 44.1 to 96 kHz; 16/24/32-bit integer, 32-bit float; Class-compliant USB 2.0 high speed or ASIO® driver (supplied via download)

Mass Storage (USB-C): USB 2.0 high speed

Keyboard, X-Keys (USB-A): Text entry and control

Thumbdrive (USB-A): Manual or auto-copy to drive

Midi Control Surface (USB-A)

USB Hub

Recording

12 Tracks: Stereo mix + 10 ISOs

44.1 kHz, 47.952 kHz, 48 kHz, 48.048 kHz, 96 kHz, 192 kHz sampling frequencies

16, 24, 32 float bit depths

Polyphonic WAV

Recording Storage

Type: SD, SDXC, SDHC Card, & USB thumbdrive (copy only)

Max Storage Size: 512 GB (SDXC)

Card format: exFAT

File Delivery to Cloud

Compatible with Viviana Cloud

Timecode

Modes: Free Run, Time of Day (file stamped w/current ToD), Rec Run, Ext LTC (file stamped w/incoming LTC on 3.5mm Aux In), Camera TC (file stamped w/incoming TC from cameras that output TC)

Frame Rates: auto-detects (fps): 23.98 (same as 23.976), 24, 25, 29.97DF, 29.97ND, 30, 30DF

Sync Source: Internal, Word Clock, Ext LTC

BNC In (TC In): switchable between Timecode (default) or Word Clock Input; 20k ohm impedance, 0.3 V - 3.0 V p-p (-17 dBu - +3 dBu); Word Clock: 10k ohm impedance, 1.5V p-p

BNC Out (TC Out): switchable between Timecode (default) or Word Clock Output; 1k ohm impedance, 3.0V p-p (+12 dBu); Word Clock: 75 ohm impedance, 5V p-p

TC Reader via HDMI

Power

AA Batteries: 8x AA sled (included); Energizer Ultimate Lithium recommended

L-Mount: Optional sled for 2x (hot-swappable) Li-ion batteries

AC Adapter: XL-WPH3 (included): Universal, 45 W in-line AC-to-DC power supply Hirose 4-pin DC plug, with detachable IEC power cord; 100-240, 50/60Hz

Remote Control

Bluetooth LE: Wireless control using Wingman app

HDMI (micro): Auto-record start/stop trigger from cameras with output record flag over HDMI

Timecode: Auto-record start/stop trigger via Aux In timecode

Environmental

Operating: -20°C to 60°C, 0 to 90% relative humidity; (non-condensing)

Storage: -40°C to 85°C

Dimensions and Weight

36 mm x 206 mm x 175 mm (H x W x D); 1.375" x 8.125" x 6.875"

Weight: 0.91 kg; 32.1 oz. (unpacked, without batteries)

Touch Screen: 320x256; 1.6-inch, color, sunlight-viewable IPS LCD

*patents #US9654134B2 (USA), #CA2973142C (Canada), and #EP3259845 (Europe)

Warranty

Sound Devices, LLC warrants the items listed above against defects in materials and workmanship for a period of ONE (1) year from date of original retail purchase. Users who register their product directly with Sound Devices Technical Support using the online form or by phone, will receive an additional ONE (1) year of warranty coverage, extending the complete warranty period to TWO (2) years from the date of original retail purchase. In order to extend the warranty coverage period, registration must be completed within the initial ONE (1) year warranty period. Products must be purchased through authorized Sound Devices resellers to qualify for Warranty coverage. Damage resulting from the opening of a Sound Devices product or attempted repairs by a non-authorized Sound Devices repair technician will void warranty coverage.

This is a non-transferable warranty that extends only to the original purchaser. Sound Devices, LLC will repair or replace the product at its discretion at no charge. Warranty claims due to severe service conditions will be addressed on an individual basis.

THE WARRANTY AND REMEDIES SET FORTH ABOVE ARE EXCLUSIVE. SOUND DEVICES, LLC DISCLAIMS ALL OTHER WARRANTIES, EXPRESS OR IMPLIED, INCLUDING WARRANTIES OF MERCHANTABILITY AND FITNESS FOR A PARTICULAR PURPOSE. SOUND DEVICES, LLC IS NOT RESPONSIBLE FOR SPECIAL, INCIDENTAL, OR CONSEQUENTIAL DAMAGES ARISING FROM ANY BREACH OF WARRANTY OR UNDER ANY OTHER LEGAL THEORY. Because some jurisdictions do not permit the exclusion or limitations set forth above, they may not apply in all cases.

For all service, including warranty repair, please contact Sound Devices for an RMA (return merchandise authorization) before sending your unit in for repair. Product returned without an RMA number may experience delays in repair. When sending a unit for repair, please do not include accessories, including SSD drives, CF cards, batteries, power supplies, carry cases, cables, or adapters unless instructed by Sound Devices. Sound Devices repairs and replacements may be completed using refurbished, returned or used parts that have been factory certified as functionally equivalent to new parts.

Sound Devices, LLC

Services Repair RMA #XXXXX

E7556 State Road 23 and 33
Reedsburg, WI 53959 USA
Telephone: +1-608-524-0625

Software License

End-user license agreement for Sound Devices MixPre Series Software / Embedded Firmware

Important Read carefully:

This Sound Devices, LLC end-user license agreement (“EULA”) is a legal agreement between you (either an individual or a single entity) and Sound Devices, LLC for the Sound Devices, LLC software product identified above, which includes computer software, embedded firmware, and may include associated media, printed materials, and “online” or electronic documentation (“SOFTWARE PRODUCT”). By using, installing, or copying the SOFTWARE PRODUCT, you agree to be bound by the terms of this EULA. If you do not agree to the terms of this EULA, do not use or install the SOFTWARE PRODUCT.

Software Product License

The SOFTWARE PRODUCT is protected by copyright laws and international copyright treaties, as well as other intellectual property laws and treaties. The SOFTWARE PRODUCT is licensed, not sold.

Grant of license. This EULA grants you the following limited, non-exclusive rights: In consideration of payment of the licensee fee, Sound Devices, LLC, as licensor, grants to you, the licensee, a non-exclusive right to use this copy of a Sound Devices, LLC software program (hereinafter the “SOFTWARE”) on a single product and/or computer. All rights not expressly granted to licensee are reserved to Sound Devices, LLC.

Software ownership. As the licensee, you own the hardware on which the SOFTWARE is recorded or fixed. Sound Devices, LLC shall retain full and complete title to the SOFTWARE and all subsequent copies of the SOFTWARE, regardless of the media or form on or in which the original copies may exist. The license is not a sale of the original SOFTWARE.

Two Level Segregated Fit memory allocator, version 3.1. Written by Matthew Conte <http://tsf.baisoku.org>

Based on the original documentation by Miguel Masmano: <http://www.gii.upv.es/tsf/main/docs>

This implementation was written to the specification of the document, therefore no GPL restrictions apply.

Copyright (c) 2006-2016, Matthew Conte

All rights reserved.

Redistribution and use in source and binary forms, with or without modification, are permitted provided that the following conditions are met: Redistributions of source code must retain the above copyright notice, this list of conditions and the following disclaimer.

Redistributions in binary form must reproduce the above copyright notice, this list of conditions and the following disclaimer in the documentation and/or other materials provided with the distribution. Neither the name of the copyright holder nor the names of its contributors may be used to endorse or promote products derived from this software without specific prior written permission.

** THIS SOFTWARE IS PROVIDED BY THE COPYRIGHT HOLDERS AND CONTRIBUTORS “AS IS” AND

** ANY EXPRESS OR IMPLIED WARRANTIES, INCLUDING, BUT NOT LIMITED TO, THE IMPLIED

** WARRANTIES OF MERCHANTABILITY AND FITNESS FOR A PARTICULAR PURPOSE ARE

** DISCLAIMED. IN NO EVENT SHALL MATTHEW CONTE BE LIABLE FOR ANY

** DIRECT, INDIRECT, INCIDENTAL, SPECIAL, EXEMPLARY, OR CONSEQUENTIAL DAMAGES

** (INCLUDING, BUT NOT LIMITED TO, PROCUREMENT OF SUBSTITUTE GOODS OR SERVICES;

** LOSS OF USE, DATA, OR PROFITS; OR BUSINESS INTERRUPTION) HOWEVER CAUSED AND

** ON ANY THEORY OF LIABILITY, WHETHER IN CONTRACT, STRICT LIABILITY, OR TORT

** (INCLUDING NEGLIGENCE OR OTHERWISE) ARISING IN ANY WAY OUT OF THE USE OF THIS

** SOFTWARE, EVEN IF ADVISED OF THE POSSIBILITY OF SUCH DAMAGE.

Copyright

All rights, title, and copyrights in and to the SOFTWARE PRODUCT (including, but not limited to, any images, photographs, animations, video, audio, music, text, and “applets” incorporated into the SOFTWARE PRODUCT) and any copies of the SOFTWARE PRODUCT are owned by Sound Devices, LLC or its suppliers. The SOFTWARE PRODUCT is protected by copyright laws and international treaty provisions. Therefore, you must treat the SOFTWARE PRODUCT like any other copyrighted material, except that you may make copies as only provided below. You may not copy the printed materials accompanying the SOFTWARE PRODUCT.

Restrictions on use. Licensee may not distribute copies of the SOFTWARE or accompanying materials to others. Licensee may not modify, adapt, translate, reverse engineer, decompile, disassemble, or create derivative works based on the SOFTWARE or its accompanying printed or written materials.

Transfer restrictions. Licensee shall not assign, rent, lease, sell, sublicense, or otherwise transfer the SOFTWARE to another party without prior written consent of Sound Devices, LLC. Any party authorized by Sound Devices, LLC to receive the SOFTWARE must agree to be bound by the terms and conditions of this agreement.

Termination

Without prejudice to any other rights, Sound Devices, LLC may terminate this EULA if you fail to comply with the terms and conditions of this EULA. In such event, you must destroy all copies of the SOFTWARE PRODUCT and all of its component parts.

Limited Warranty

No warranties. Sound Devices, LLC expressly disclaims any warranty for the SOFTWARE PRODUCT. The SOFTWARE PRODUCT and any related documentation is provided “as is” without warranty or condition of any kind, either express or implied, including, without limitation, the implied warranties and conditions of merchantability, fitness for a particular purpose, or non-infringement. The entire risk arising out of use or performance of the SOFTWARE PRODUCT remains with you.

No liability for damages. In no event shall Sound Devices, LLC or its suppliers be liable for any damages whatsoever (including, without limitation, damages for loss of business profits, business interruption, loss of business information, or any other pecuniary loss) arising out of the use of or inability to use this Sound Devices, LLC product, even if Sound Devices, LLC has been advised of the possibility of such damages. In any case, Sound Devices, LLC’s entire liability under any provision of this evaluation license shall be limited to the greater of the amount actually paid by you for the SOFTWARE PRODUCT or U.S. \$5.00. Because some states/jurisdictions do not allow the exclusion or limitation of liability for consequential or incidental damages, the above limitation may not apply to you.

Legal Notices

Product specifications and features are subject to change without prior notification.

Governing Law

This agreement and limited warranty are governed by the laws of the state of Wisconsin.

FCC & ISED Compliance Statements



This device complies with part 15 of the FCC Rules. Operation is subject to the following two conditions: (1) This device may not cause harmful interference, and (2) this device must accept any interference received, including interference that may cause undesired operation. FCC Part 15.19 (a) (3)

Changes or modifications not expressly approved by the party responsible for compliance could void the user’s authority to operate the equipment.

FCC Interference Statement

This equipment has been tested and found to comply with the limits for a Class B digital device, pursuant to part 15 of the FCC Rules. These limits are designed to provide reasonable protection against harmful interference in a residential installation. This equipment generates, uses and can radiate radio frequency energy and, if not installed and used in accordance with the instructions, may cause harmful interference to radio communications. However, there is no guarantee that interference will not occur in a particular installation. If this equipment does cause harmful interference to radio or television reception, which can be determined by turning the equipment off and on, the user is encouraged to try to correct the interference by one or more of the following measures:

- Reorient or relocate the receiving antenna.
- Increase the separation between the equipment and receiver.
- Connect the equipment into an outlet on a circuit different from that to which the receiver is connected.
- Consult the dealer or an experienced radio/TV technician for help.

FCC & ISED User Statement

This device complies with FCC and ISED RF Exposure SAR limits exposure limits for general population / uncontrolled exposure.

Cet appareil est conforme à la norme FCC et USED RF Exposure SAR limite les limites d’exposition pour la population générale / l’exposition incontrôlée.

This Device complies with Industry Canada License-exempt RSS standard(s). Operation is subject to the following two conditions: 1) this device may not cause interference, and 2) this device must accept any interference, including interference that may cause undesired operation of the device.

Cet appareil est conforme avec Industrie Canada, exempts de licence standard RSS (s). Son fonctionnement est soumis aux deux conditions suivantes: 1) ce dispositif ne peut pas causer d'interférences, et 2) ce dispositif doit accepter toute interférence, y compris les interférences qui peuvent causer un mauvais fonctionnement de l'appareil.

Copyright© 2022 Sound Devices, LLC. All rights reserved.

This product is subject to the terms and conditions of a software license agreement provided with the product, and may be used in accordance with the license agreement.

This document is protected under copyright law. An authorized licensee of this product may reproduce this publication for the licensee's own personal use. This document may not be reproduced or distributed, in whole or in part, for commercial purposes, such as selling copies or providing educational services or support.

This document is supplied as a technical guide. Special care has been taken in preparing the information for publication; however, since product specifications are subject to change, this document might contain omissions and technical or typographical inaccuracies. Sound Devices, LLC does not accept responsibility for any losses due to the user of this guide.

Trademarks

The "wave" logo is a registered trademark and Kashmir is a trademark of Sound Devices, LLC. iPad, iPhone, Mac and OS X are trademarks of Apple Inc., registered in the U.S. and other countries. Windows is a registered trademark of Microsoft Corporation in the U.S. and other countries. Bluetooth Smart is a registered trademark of Bluetooth SIG, Inc. ASIO is a registered trademark of Steinberg Media Technologies. All other trademarks herein are the property of their respective owners.

WEEE Statement

If you wish to discard a Sound Devices product in Europe, contact Sound Devices (England) for further information.



Warning! This device can drive headphones to potentially dangerous levels. Do not listen at high volume levels for long periods.



Read and fully understand this manual before operation.

SOUND  **DEVICES**

Post Office Box 576
E7556 State Rd. 23 and 33
Reedsburg, Wisconsin 53959 USA

support@sounddevices.com

+1608.524.0625 main
800.505.0625 toll free (U.S. only)

www.sounddevices.com