

Switchcraft®

StudioPatch™ Series

Audio Patchbays

Operation Manual



Thank you for purchasing a StudioPatch Series audio patchbay by Switchcraft®. This product was proudly manufactured in the United States.

The StudioPatch Series (6425 and 9625) are professional TT, 32 and 48 channel audio patchbays that are capable of handling analog, as well as AES/EBU digital audio signals. They can directly connect to any piece of audio equipment that uses standard, eight-channel DB25 (also known as DSUB) connectors, such as TASCAM® DTRS decks, Digidesign® Pro Tools HD systems, Mackie® mixers, line cards, I/O's, and much more. They can also directly connect to any piece of audio equipment that uses traditional analog I/O's, such as XLR or TRS, through the use of a wide range of DB25 breakout cable. The connection possibilities are virtually limitless.

What makes the StudioPatch Series so unique is how they allow you to configure the channels for routing your audio signals. The normalling of each channel can be set to full, half, or non-normal configurations from the front of the unit, with the simple twist of a regular screwdriver.

Contained in this manual, are some things you should know about installing, configuring, and caring for this unit. Should you have any additional questions, please feel free to contact your local Switchcraft® dealer / representative, or call us directly at (773) 792-2700, and ask for the customer service department.

Serial Number

Date of Purchase

Place of Purchase

*StudioPatch™ is a trademark of Switchcraft®, Inc.

*TASCAM® and DTRS are trademarks of TEAC Corporation.

*Pro Tools is a trademark of Digidesign®.

*Digidesign® is a division of Avid Technology, Inc.

*Mackie® is a trademark of LOUD Technologies Inc.

All other trademarks are property of their respective holders.

Specifications subject to change without notice.

Table of Contents

What is a Patchbay and Why is it Used?	Page 3
Detailed View	Page 4
Connecting the StudioPatch Series Patchbay	Page 5
Types of Connecting Cables	Page 5, 6
Connection Examples	Page 7-9
Connecting for Digital Audio	Page 10
What Are Normals	Page 10
Phantom Power	Page 10
Setting The Normals	Page 11–13
Designation Strips	Page 14
Do's And Don'ts	Page 15
Questions And Answers	Page 16
Accessories	Page 17
DB25 Connector Pinout Diagram	Page 18
Cannon DL Connector Pinout Diagram (StudioPatch Series 96DL)	Page 19
Warranty	Page 20

What is a Patchbay and Why is it Used?

A Brief History

The first audio patchbays were developed for the telephone industry. At the time, the main use of the patchbay, also known as the jackfield, was for telephone operators to manually route calls from one region to another. As technology advanced, the patchbay made its way into recording studios, radio stations, television broadcast facilities, and virtually anyplace that needed to route audio and/or video signals from one place to another. In a recording studio, patchbays are used to connect and route various pieces of equipment such as audio consoles, tape machines, outboard effects processors, digital audio workstations, etc.

Today

With modern digital technology constantly interfacing with high-quality analog equipment in all aspects of professional audio and broadcasting, it is essential to maintain fast, flexible routing options capable of working with digital and/or analog audio signals. At Switchcraft, we realize that the needs of audio engineers can be drastically different depending on their particular situation. Flexibility is critical!

INTRODUCING...

StudioPatch™ Series Audio Patchbay

Analog

StudioPatch Series (6425 and 9625) audio patchbays are designed with industry standard DB25 (also known as DSUB) I/O connectors. The pinouts follow the same standards used by Tascam®, Digidesign®, and many other audio product manufacturers. It is important to note, however, that you are not limited to using only equipment with DB25 connections. You can choose from a wide variety of DB25 breakout cabling options enabling you to connect to virtually any piece of audio equipment quickly and easily. You might decide, for example, that having patchbay access to your audio consoles direct outputs would come in handy. Assuming that your consoles direct outputs are 1/4-inch TRS, this would require a cable consisting of one DB25 male connector to eight, 1/4-inch TRS plugs. The same can be done for any of the analog inputs and outputs of your console, outboard gear, digital audio workstation, tape machine, etc. allowing for the most flexible and versatile audio processing environment. The routing possibilities are endless!

Digital

Another great feature of the StudioPatch Series of audio patchbays, is that they are capable of routing AES/EBU digital audio signals, which carry two channels of interleaved digital audio data through one standard balanced audio cable. For example, four XLR cables would carry eight channels of AES/EBU digital audio data. Therefore, when connecting AES/EBU digital signals using DB25 connectors, you are capable of transmitting eight and receiving eight channels of audio through one DB25 cable.

**Note: AES/EBU signals require the use of 110 ohm digital grade cable.*

**Note: AES/EBU is not to be confused with a TDIF signal.*

StudioPatch™ 6425

Front View

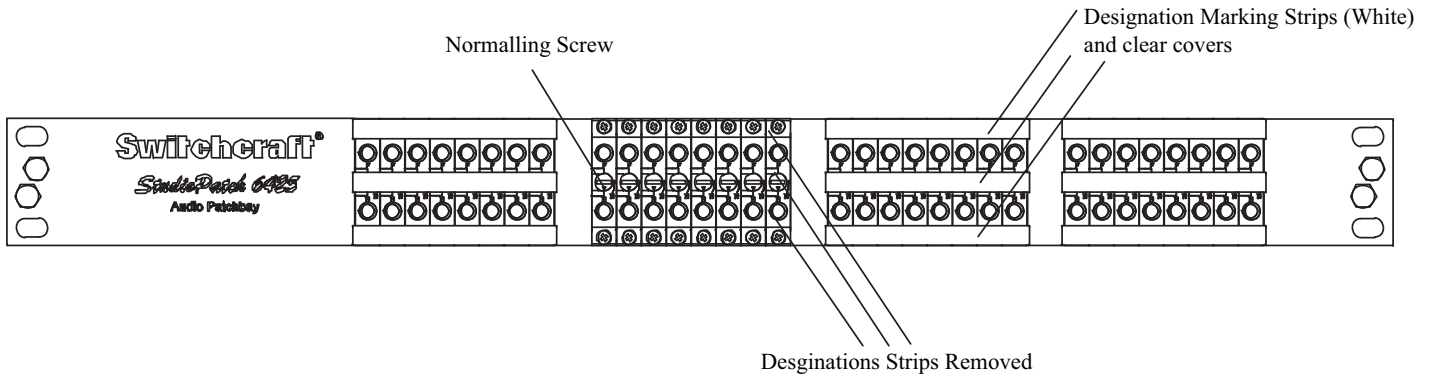

Rear View

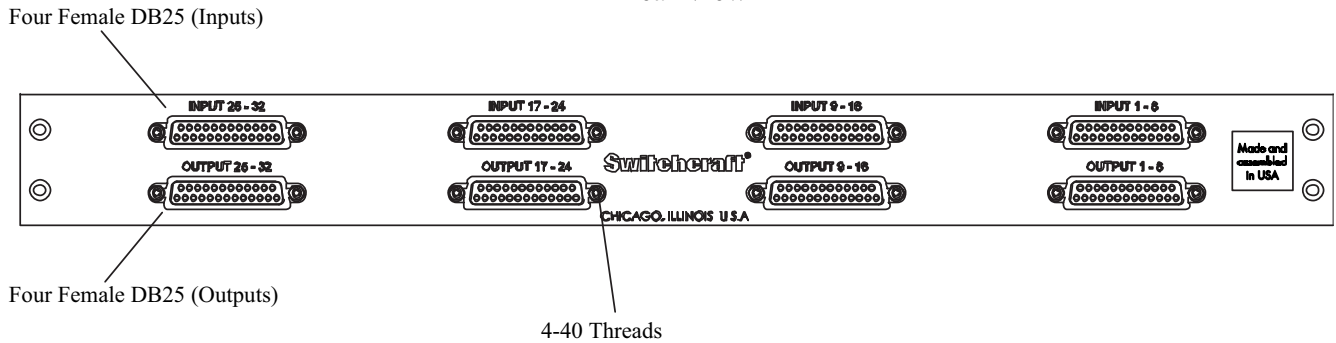

Normalling Positions

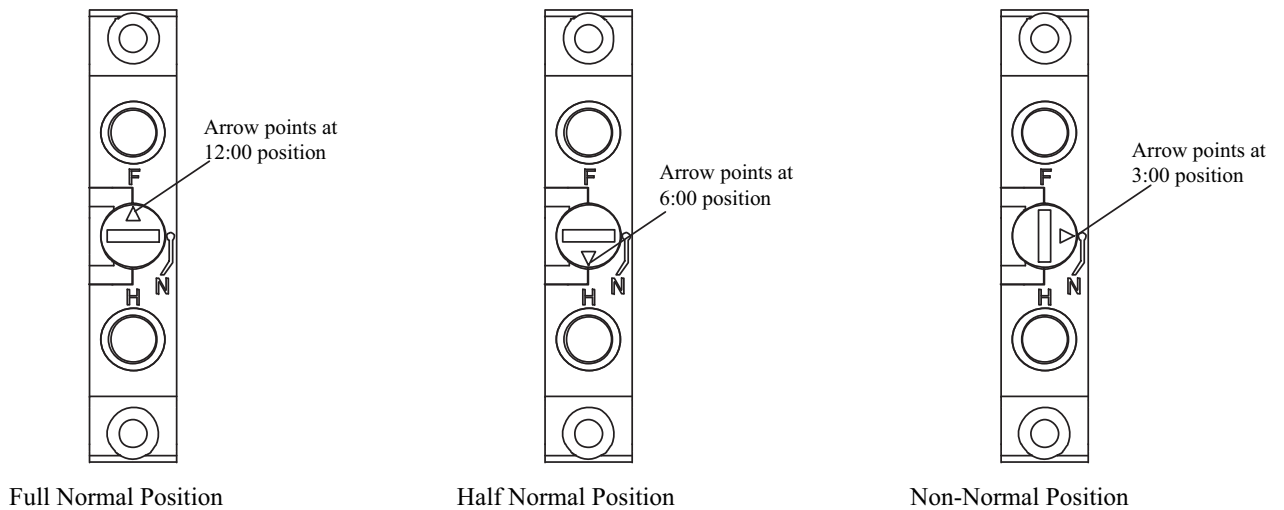

Note: Do not rotate screw counter-clockwise from left of "F" and left of "H"

Connecting The *StudioPatch™ Series* (6425 and 9625)

Connecting for analog audio

StudioPatch Series (6425 and 9625) audio patchbays will connect directly to any piece of equipment with an analog DB25 I/O connection using a standard DB25 male to male cable. In an analog audio environment, DB25 cable carries eight balanced audio signals to and from various pieces of equipment. The DigiDesign® DigiSnake series is recommended for the StudioPatch Series (6425 and 9625), however, there are multiple manufacturers that make cable with this particular wiring scheme, or pinout. These cables are often referred to as "DA-88 cables". They are compatible with Tascam® DTRS series tape machines (such as the DA-88), and are an industry standard used by many other audio product manufacturers. Whether you are connecting to a multi-track recorder, audio console, digital audio workstation interface, or any piece of audio equipment that has a DB25 connector on the unit, the StudioPatch Series can directly link to it.

It is important to keep in mind, however, that while most DB25 connectors utilize the standard Tascam DTRS pinout, there are other uses for DB25 cable that have different wiring schemes. Please make sure that your gear utilizes the appropriate pinout.

As mentioned earlier, you are not limited to using only analog I/O's with DB25 connections. There are many variations of DB25 breakout cable readily available. Two of the most common (DB25 to XLR & DB25 to TRS) can be seen on the next page.

Types of Cables

DB25 Male to Male Cable

(Also Known as DA-88 Cable)



*TASCAM® and DTRS are trademarks of TEAC Corporation.

*Pro Tools is a trademark of DigiDesign.

*DigiDesign® is a division of Avid Technology, Inc.

*DigiSnake is a trademark of DigiDesign®.

DB25 Male to XLR

(Also Known as DA-88 to XLR Breakout Cable)

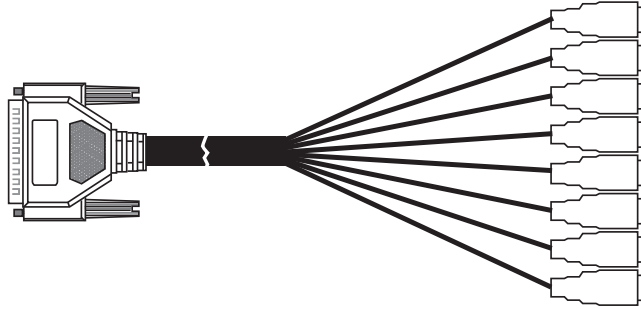

DB25 Male to 1/4" (TRS)

(Also Known as DA-88 to 1/4" TRS Breakout Cable)

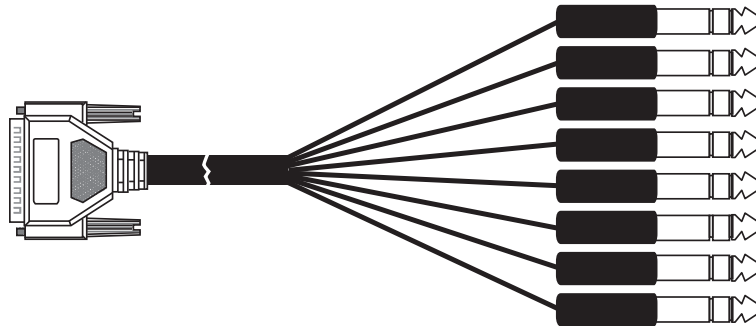

The rear panels of the StudioPatch Series (6425 and 9625) have a total of either eight or twelve female 25 Pin DB25 (or DSUB) connectors depending on whether you have purchased the 64 or 96 point versions. The top row of connectors are for inputs, and the bottom row are for outputs. Each DSUB can carry eight channels of balanced analog audio, or sixteen channels of AES/EBU standard digital audio.



StudioPatch Series patchbays can be placed in-between your source and destination gear. The outputs of your source gear can connect directly to the inputs of the StudioPatch Series. Conversely, the outputs of the StudioPatch Series can be connected to the inputs of your destination gear (See Example 1).

Example 1

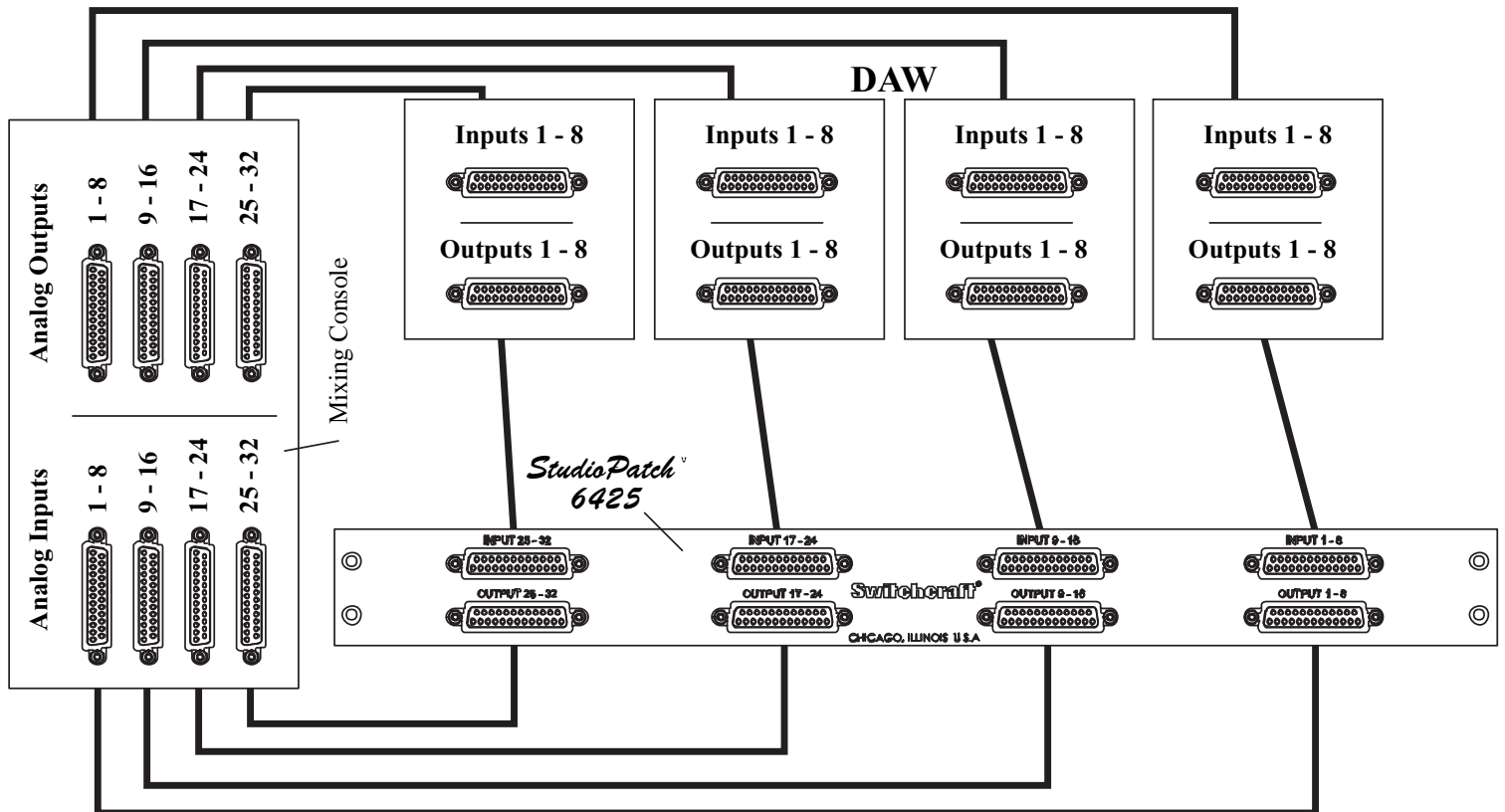

Example 1 shows a StudioPatch Series (6425) connected to four DAW (digital audio workstation) interfaces and a mixing console. All units have DB25 I/O's. This configuration is giving patchbay access to channels 1 through 32 of the mixing console's analog inputs, and 1 through 32 of the DAW's analog outputs. This enables a user to reroute signals (via patchcord) to different areas. Outboard devices can also be added to individual channels of the patchbay for even more flexibility. In this example, the normalling screw would most likely be set to either the half normal ("H") position, or full normal ("F"). In either of these cases, when there is no patchcord plugged in, the normal signal passes through the channel of the patchbay as if the inputs and outputs were directly connected.

Note: See Pages 10-13 for "Normals" definitions and explanations.

DB25 Breakout Cable

As mentioned earlier, another way to connect the StudioPatch Series (6425 and 9625) is with DB25 breakout cable. In this example, your setup would have a DB25 connector on one end (let's say the analog DAW I/O), and XLR's to the destination (the mixing console).

In this example, you would connect your mixing console's eight XLR outputs 1 through 8 to the DAW's DB25 analog inputs 1 through 8. From the DAW's DB25 analog outputs 1 through 8, you would connect to the StudioPatch Series' DB25 inputs 1 through 8. From there, you would connect the StudioPatch Series' DB25 outputs 1 through 8 to the mixing console's XLR inputs 1 through 8 (See Example 2).

Example 2

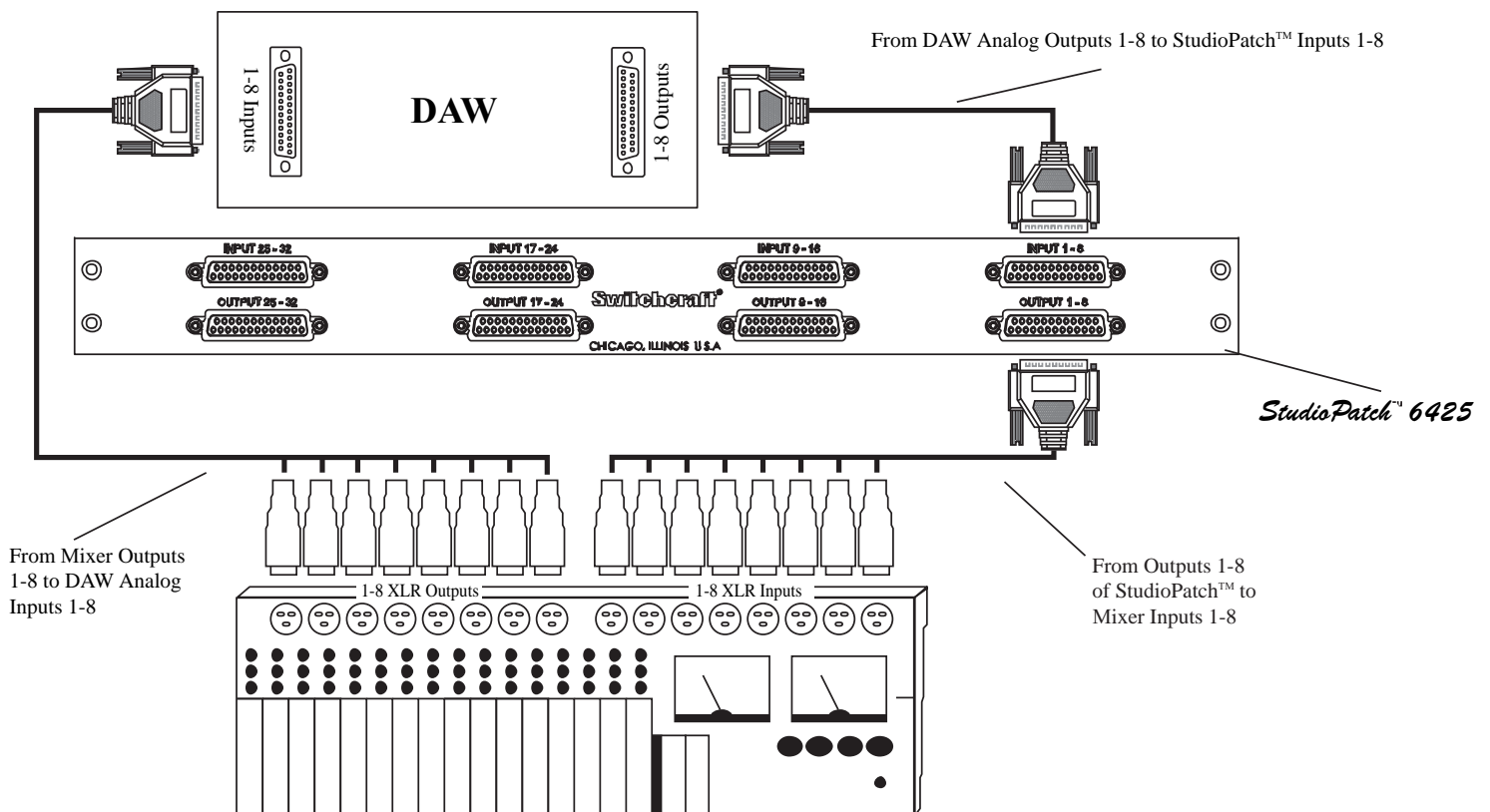

Depending on your particular studio setup, you may have a variety of combinations of cable connector ends. In this case, you would need:

- 1 – Eight channel XLR (female) to DB25 (male).
- 1 - DB25 (male) to DB25 (male).
- 1 - DB25 (male) to eight channel XLR (male).

Example 3

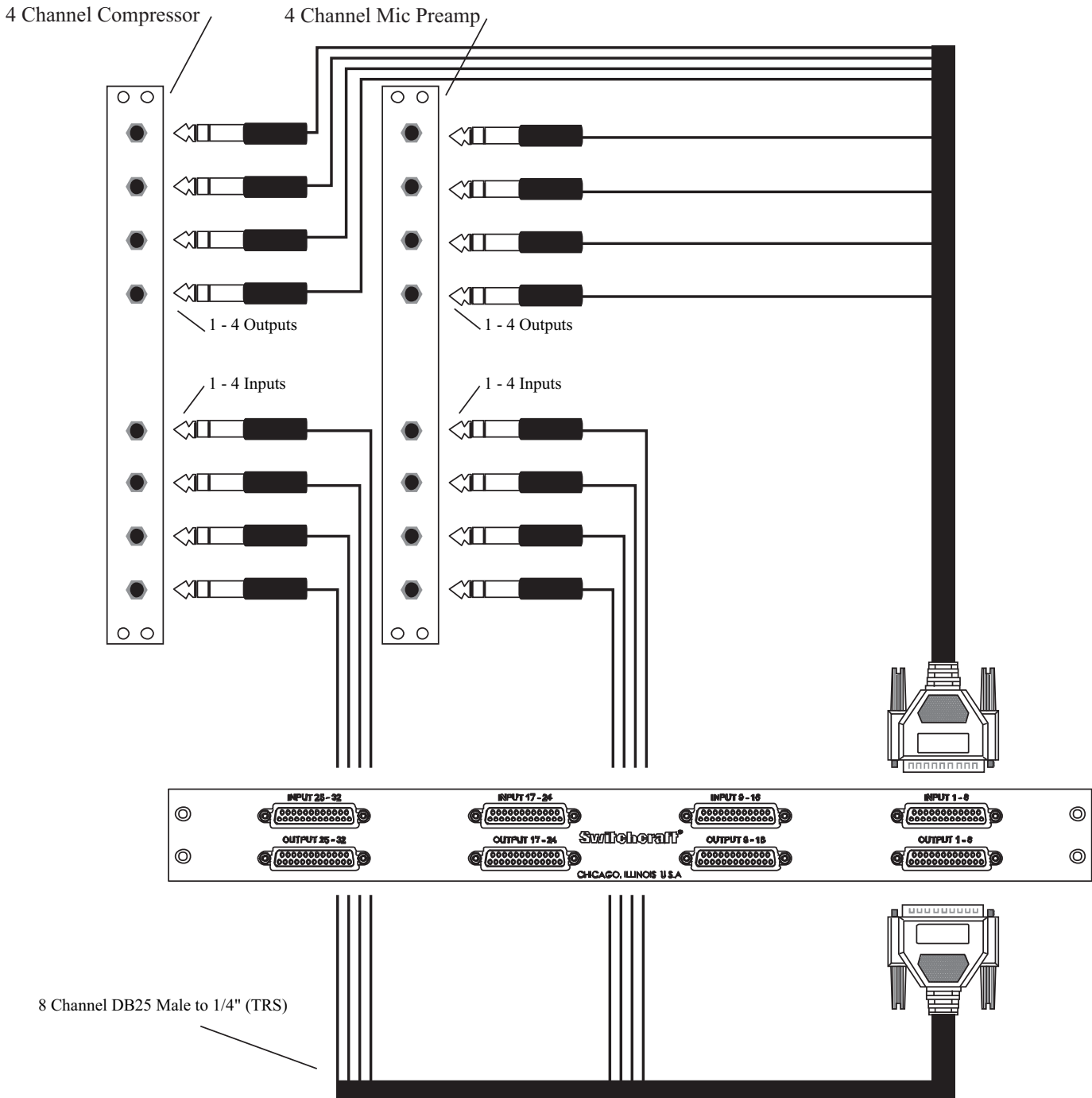

In example 3, the StudioPatch Series (6425) is connected to a four-channel compressor, and a four-channel microphone preamp. Since these two outboard devices use a total of eight channels, one DB25 to 1/4-inch TRS breakout cable can be used for all of the inputs, and one can be used for all of the outputs. The patchbay's channels 1 through 8 will then have the compressor and mic-pre outputs on the top row, and the compressor and mic-pre inputs on bottom row. In this case, the normalling screw would most likely be set for non-normalled ("N" position) to prevent the possibility of unwanted feedback loops.

Now, the patchbay has 48 patchpoints, or 24 channels left that can be used. Keep in mind, that you can create any type of configuration that you wish...this is just one example. The jacks do not all have to be normalled the same way in groups. It all depends on your particular configuration.

Note: See Pages 10-13 for "Normals" definitions and explanations.

Connecting the *StudioPatch* "Series" for AES/EBU Digital Audio Signals

The StudioPatch Series can also be used for patching AES/EBU digital audio signals. AES/EBU was developed by the Audio Engineering Society and the European Broadcasting Union as a way to transfer digital audio signals between devices. Conveniently, it uses the same cable configuration as balanced analog audio, where pin 1 connects to ground, and pins 2 and 3 carry the audio information. The major difference is that one AES/EBU cable carries two channels of digital audio. Typically, when you use DB25 cable for AES/EBU digital audio signals, you are transmitting 8, and receiving 8 channels of digital audio through one DB25 cable. Traditionally, with analog signals, patchbay outputs are across the top row, and inputs are across the bottom row. This, however, will not be the case when connecting the StudioPatch Series to an AES/EBU I/O using DB25 connectors. You could potentially have inputs and outputs mixed across either the top or the bottom row depending on how you want to set it up. Also, if you do decide to use AES/EBU signals in connecting the patchbay, keep in mind that digital signals only connect to other digital signals of the same format.

Also important to remember, is that AES/EBU digital audio signals require low capacitance cable, specifically, with an impedance rating of 110 Ohms. By using standard analog cable in digital audio data transfer, which is typically 60 Ohms, errors may occur. It is very important that the correct cable is specified. As mentioned previously, the DigiDesign® DigiSnake series cable is 110 Ohm rated. If using other brands, be sure that it is also 110 Ohm rated. This will be printed on the package, or at times, on the cable's jacket itself. It is good to keep in mind that 110 Ohm cable will work fine for analog audio as well. The quality of your cable drastically impacts the quality of your sound.

Due to the necessity of keeping 110 Ohm impedance for AES/EBU digital audio signals, it is not recommended that you use the jacks in the half-normalled position. When a plug is inserted into the source jack (top row) while the jack is in the half-normalled position (as explained in the following sections), the signal is split in parallel, effectively cutting the impedance in half, leaving the source to see 55 Ohms. This is not an acceptable situation for proper transmission of AES/EBU digital audio signals. If this occurs, your equipment will probably not work, and may become damaged.

What Are Normals

Normals are wiring schemes whereby a signal path is established from one audio device to another without the use of a patchcord. This is known as the "normal path". The normal path between two jacks is most commonly wired internally from the source jack (the top row) to the destination jack (the bottom row).

Plugging a patchcord into one of the normalled jacks will break the normal switch connections, allowing the user to reroute the signal path through the patchcord. When the patch cord is unplugged from the jack, the normal path is restored.

In traditional patchbays, normal paths may be installed all at once or may be field-configured as the equipment changes. The StudioPatch Series, however, allows you to change the normal path with a twist of a screwdriver!

Phantom Power

If you decide that you would like to route condenser microphone signals through the patchbay, the StudioPatch Series is capable of passing phantom power. The grounds of the patchbay have been internally bussed at the factory. This will not electrically affect other analog signals being routed through StudioPatch Series patchbays.

*****Important Note:** You should always turn off your phantom power supply before plugging in or rerouting a condenser microphone's signal. Not doing so can cause permanent damage to certain microphones and other pieces of gear in your studio. It is recommended that you power off all of your studio gear before plugging in or removing patch cables from the patchbay whether you are utilizing phantom power or not.

*DigiSnake is a trademark of DigiDesign®.

*DigiDesign® is a division of Avid Technology, Inc.

Non-Normalled Position (with grounds bussed)

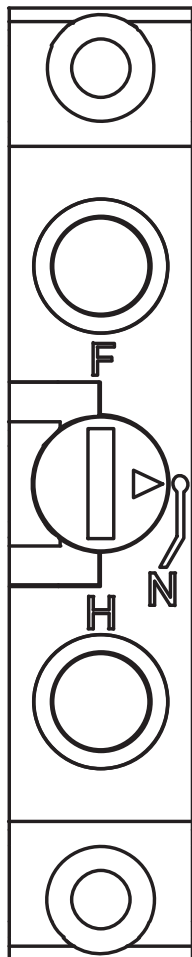
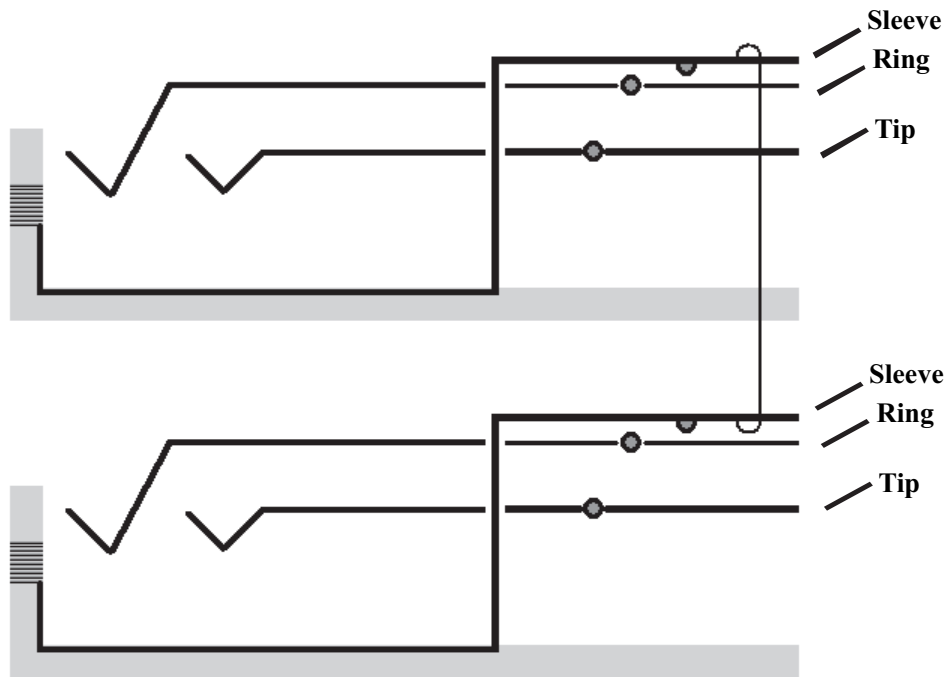

A non-normal signal path occurs when the screw cam is set in the "N" position (only the tip, ring, and sleeve contacts are utilized). Since there are no normal connections on the jacks, there can be no normal path; the signal moves straight through and cannot be interrupted via the insertion of a patch cord. In other words, the source signal (top row) will not automatically be routed to the destination (bottom row) without manually being patched with a patchcord on the front of the unit.

Turn arrow clockwise to this position for Non-Normal function.

Half Normalled Position (with grounds bussed)

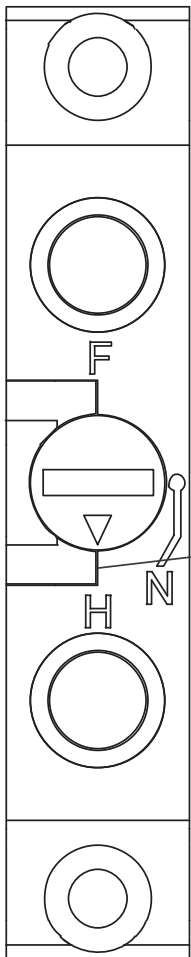
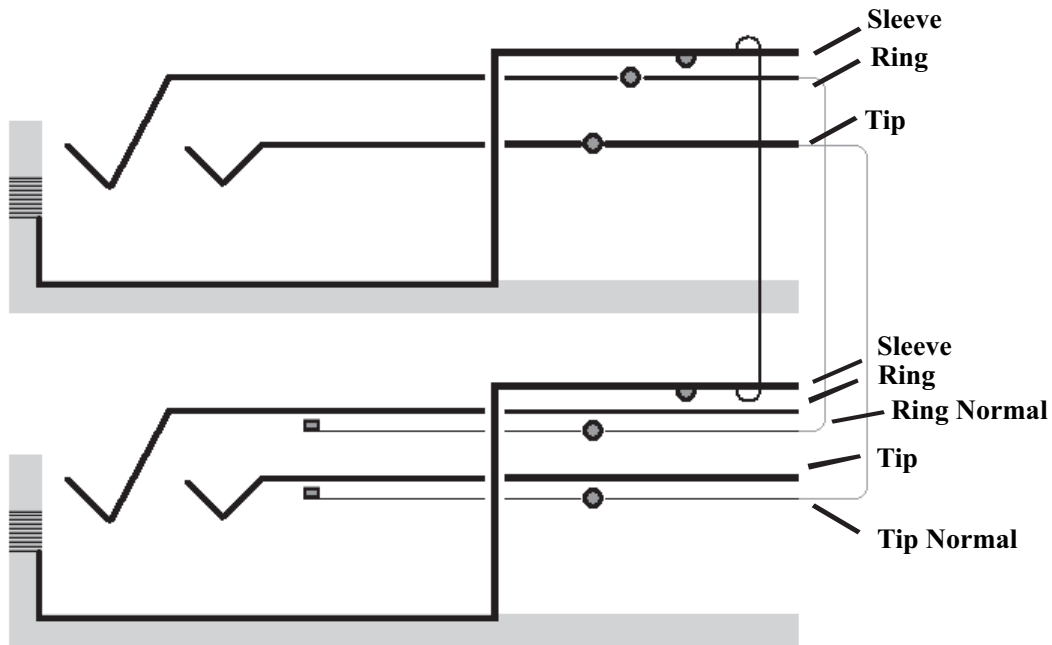

A half-normal position occurs when the screw cam is set in the "H" position. Both tip and ring connections of the source jack (top) are wired respectively to the tip normal and ring normal connections of the destination jack (bottom). Plugging a patch cord into the source jack allows the user to monitor the source signal without interrupting the normal path. The normal path can be interrupted and redirected only by inserting a plug into the destination jack (For use with analog signals only, see AES/EBU section).

Turn arrow clockwise to this position for Half Normal function.

Full Normalled Position (with grounds bussed)

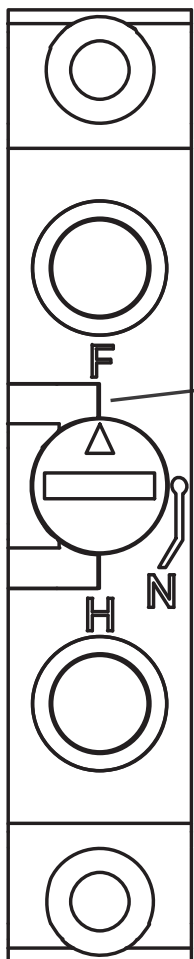
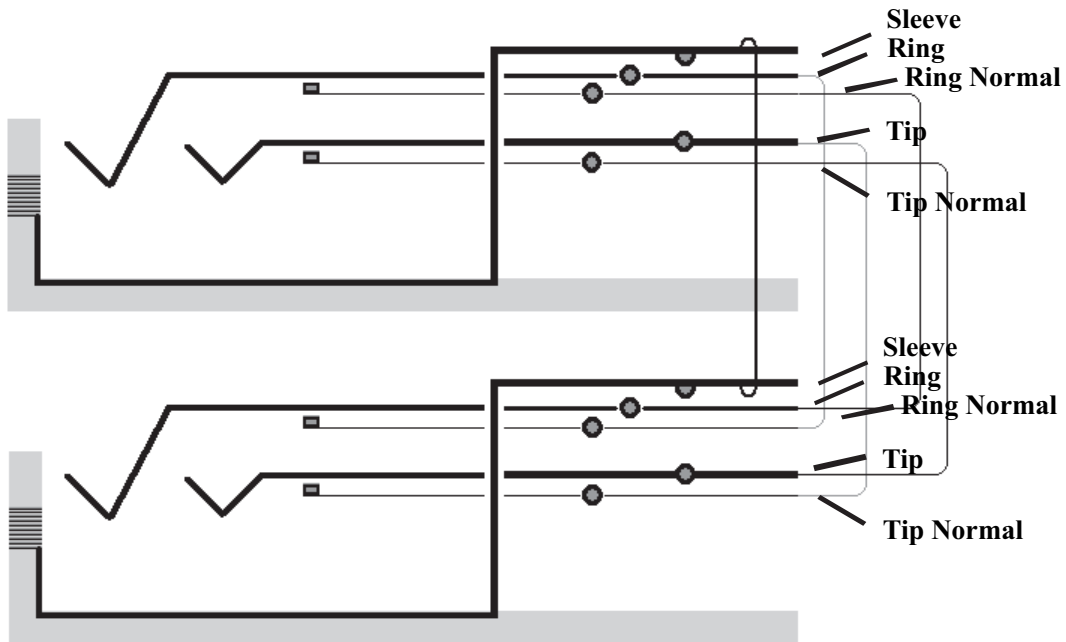

A full-normal position occurs when the screw cam is set in the "F" position. The jack's primary and normalling contacts are fully wired together from top to bottom. This normal signal path can be interrupted and redirected by plugging a patch cord into either jack.

Turn arrow clockwise to this position for Full Normal function.

Designation Strips

Provided with your StudioPatch Series patchbay, are multiple designation strips and clear plastic designation windows. There are eight white, two-sided strips, and four that are black on one side, and white on the other. The all white strips are for labeling the source and destination jacks. The black and white strips are either for labeling the center row (white side) or covering the screw cams from being visible (black side).



After labeling your designation strips, simply press the strip into the clear designation window. The designation window then snaps onto the top lip above the jack hole, then press down until the cover snaps onto the bottom lip. Repeat the same process for the area between the jack holes and the bottom row.

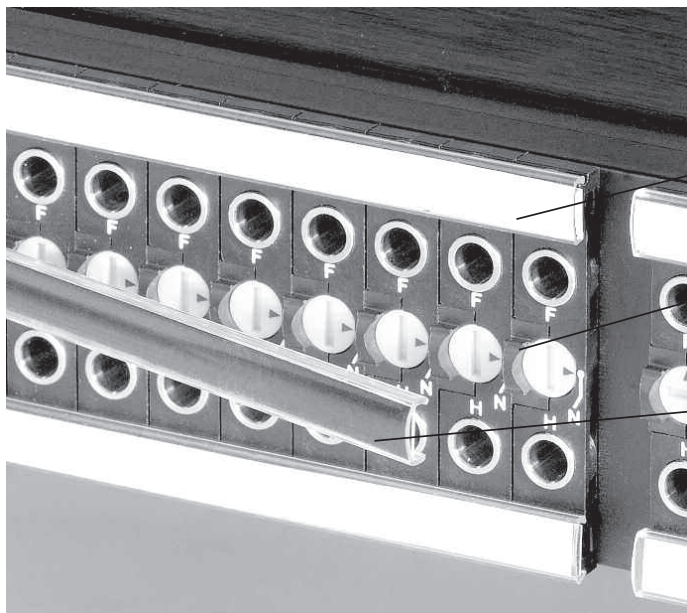

Designation and marking strip snapped onto the module's top and bottom lip.

Top and bottom lip that the designation cover snaps onto.

Center row designation strip with black side showing (opposite side is white).

Do's and Don'ts

It is very important that your StudioPatch Series patchbay is well cared for. Listed below are a few things to remember:

- Do not use a jack in the half-normalled position with a digital (AES/EBU) audio signal and insert a plug into the source (top) jack (see AES/EBU section).
- It is highly recommended to use only genuine Switchcraft® patchcords. See page 17 for a listing of available types for this patchbay unit. Improper patchcords can damage or stretch the contacts inside of the patchbay making channels intermittent or inoperable.
- Over time, the StudioPatch Series patchbay may require cleaning. Scratchy or intermittent noise may be an indication that the patchbay requires cleaning. Simply insert a patchcord plug into the jack a few times and/or rotate the cam back and forth. The inner contacts are self-cleaned when the cam is rotated.
- Do not rotate the normalling screws in a full circle. The red arrow should only move clockwise between the "F" position (12:00) and "H" (6:00) position.
- Do not use a burnishing tool. A burnishing tool will scratch the contact surfaces and will cause noise and intermittent signal problems.
- Do not use solutions to clean the jacks. Solutions may negatively interact with the metal surfaces and plastic housings.
- Do not plug in or unplug cables from the patchbay while signal is running through it. Power down all of your gear before you disconnect it.
- If removing the jack modules or opening the unit for any reason, you are voiding the warranty.
- Tampering with the jacks or cover of the unit will void the warranty.

Questions & Answers

Question:

Why is the patchbay still outputting signal to the normal destination when a patchcord is plugged in?

Answer:

The normal screw may be set to the half normal position. Set it to full normal or non-normal and the output will go only to the patchcord.

Question:

Why are the inputs on the top row and the outputs on the bottom row when it should be reversed?

Answer:

Make sure that any cables going to and coming from the StudioPatch are reaching their desired inputs and/or outputs.

Question:

If I engage phantom power on my mixing console, will it pass through StudioPatch Series patchbays?

Answer:

Yes, it will.

Question:

Since phantom power runs through the whole patchbay, will it affect devices that I have plugged into the patchbay other than condenser microphones?

Answer:

No, it should not.

Question:

If some of the channels should become "scratchy" sounding should I use contact cleaner, other solvents, or a burnishing tool to clean the jack contacts?

Answer:

No! You may damage the material that the jacks are made up of. Instead rotate the cam screw back and forth which will wipe the contacts clean inside, or insert and remove repeatedly a nickel plated patchcord (not brass). The contacts in StudioPatch Series patchbays are designed to be self-cleaning.

Question:

Can I open up the patchbay to modify the wiring?

Answer:

You can, but in doing so, you will void the warranty.

Question:

Can I use the half-normalled jack position to split / monitor AES/EBU digital signals?

Answer:

No. It is not recommended. (See AES/EBU section)

Accessories

Although there are multiple brands of patchcords available that will work with Studiopatch Series patchbays, it is recommended that only genuine Switchcraft® brand patchcords be used. At Switchcraft®, we make sure that our products work well together. The jacks we manufacture in our patchbays are designed to correctly fit the plugs we make. The plating of the metals match each other correctly. We take the extra step to use high quality, low capacitance cable, as well as provide extra shielding and a strong strain relief over the connection where the plug meets the cable.

Cheap patchcords may initially save a few dollars, but in the long run, faulty designs and inadequate materials jeopardize the signal quality and functionality of the patchbay.

TT Patchcords

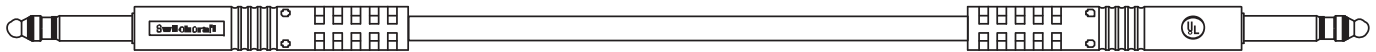

TT1BK (1' Black)	TT1BL (1' Blue)	TT1R (1' Red)	TT1GN (1' Green)
TT2BK (2' Black)	TT2BL (2' Blue)	TT2R (2' Red)	TT2GN (2' Green)
TT3BK (3' Black)	TT3BL (3' Blue)	TT3R (3' Red)	TT3GN (3' Green)
TT4BK (4' Black)	TT4BL (4' Blue)	TT4R (4' Red)	TT4GN (4' Green)
TT5BK (5' Black)	TT5BL (5' Blue)	TT5R (5' Red)	TT5GN (5' Green)
TT6BK (6' Black)	TT6BL (6' Blue)	TT6R (6' Red)	TT6GN (6' Green)
TT7BK (7' Black)	TT7BL (7' Blue)	TT7R (7' Red)	TT7GN (7' Green)
TT8BK (8' Black)	TT8BL (8' Blue)	TT8R (8' Red)	TT8GN (8' Green)
TT9BK (9' Black)	TT9BL (9' Blue)	TT9R (9' Red)	TT9GN (9' Green)
TT10BK (10' Black)	TT10BL (10' Blue)	TT10R (10' Red)	TT10GN (10' Green)
TT1GY (1' Gray)	TT1O (1' Orange)	TT1P (1' Purple)	TT1Y (1' Yellow)
TT2GY (2' Gray)	TT2O (2' Orange)	TT2P (2' Purple)	TT2Y (2' Yellow)
TT3GY (3' Gray)	TT3O (3' Orange)	TT3P (3' Purple)	TT3Y (3' Yellow)
TT4GY (4' Gray)	TT4O (4' Orange)	TT4P (4' Purple)	TT4Y (4' Yellow)
TT5GY (5' Gray)	TT5O (5' Orange)	TT5P (5' Purple)	TT5Y (5' Yellow)
TT6GY (6' Gray)	TT6O (6' Orange)	TT6P (6' Purple)	TT6Y (6' Yellow)
TT7GY (7' Gray)	TT7O (7' Orange)	TT7P (7' Purple)	TT7Y (7' Yellow)
TT8GY (8' Gray)	TT8O (8' Orange)	TT8P (8' Purple)	TT8Y (8' Yellow)
TT9GY (9' Gray)	TT9O (9' Orange)	TT9P (9' Purple)	TT9Y (9' Yellow)
TT10GY (10' Gray)	TT10O (10' Orange)	TT10P (10' Purple)	TT10Y (10' Yellow)

StudioPatch™ Series 6425/9625 DB25 Connector Pinout

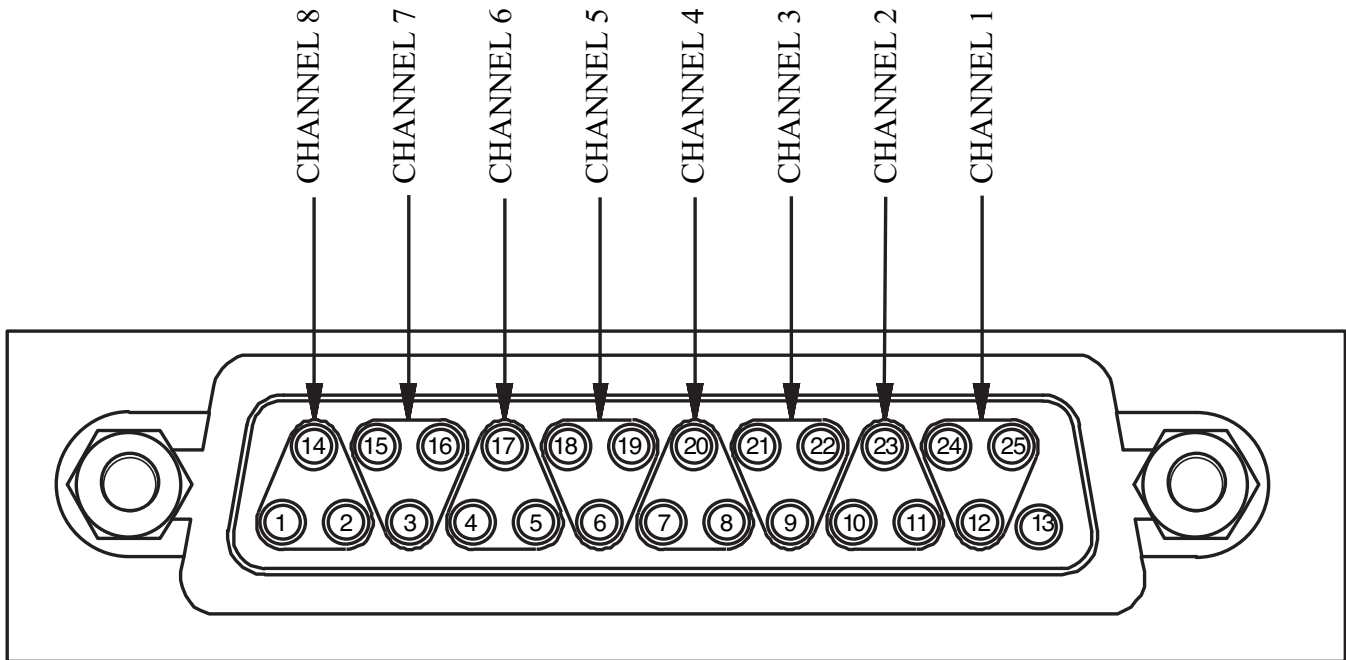

DB25 Wiring Chart

Jack (Channel)	Tip (White)	Ring (Black)	Sleeve (Bare)
1	24	12	25
2	10	23	11
3	21	9	22
4	7	20	8
5	18	6	19
6	4	17	5
7	15	3	16
8	1	14	2

StudioPatch™ 96DL

The StudioPatch Series 96DL is a professional TT, 48 channel audio patchbay. It has all of the same features as the StudioPatch 9625. The only difference, however, is that the rear I/O section consists of four Cannon DL style connectors. Below, is the Cannon DL pinout and wiring chart used for the StudioPatch Series 96DL.

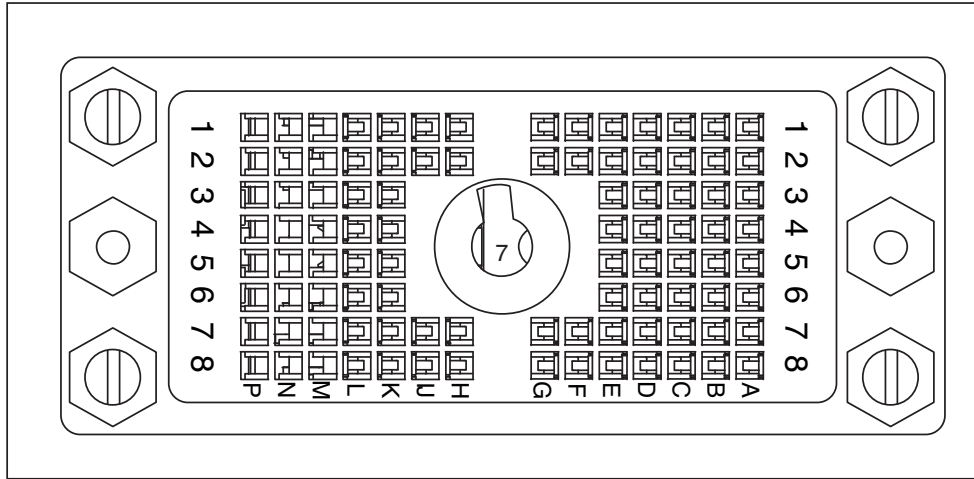

WIRING CHART			
JACK NO	TIP	RING	SLEEVE
1	A1	B1	C1
2	A2	B2	C2
3	A3	B3	C3
4	A4	B4	C4
5	A5	B5	C5
6	A6	B6	C6
7	A7	B7	C7
8	A8	B8	C8
9	D1	E1	F1
10	D2	E2	F2
11	D3	E3	G1
12	D4	E4	G2
13	D5	E5	G7
14	D6	E6	G8
15	D7	E7	F7
16	D8	E8	F8
17	L1	K1	J1
18	L2	K2	J2
19	L3	K3	H1
20	L4	K4	H2
21	L5	K5	H7
22	L6	K6	H8
23	L7	K7	J7
24	L8	K8	J8

Wiring Notes:

- 1) Pinouts repeats for each set of 24 jacks and for both input and output.
- 2) All grounds (sleeves) bussed together

Limited Lifetime Warranty

Switchcraft® warrants all of its products to be of sound design, good materials and workmanship at the time of manufacture.

Switchcraft® will repair or replace at its discretion any product proven to be defective under normal use.

Switchcraft®'s liability under terms of this warranty is limited to the repair or replacement of defective products which have not been damaged through accident, abuse, misuse or unauthorized repair. Switchcraft® shall in no case be liable for special or consequential damages of any nature.

File your paperwork and document your serial number to this owner's manual. Register your serial number by filling out and sending the section below to Switchcraft®, Inc.

Switchcraft®

5555 North Elston Avenue • Chicago, IL 60630

773-792-2700 • Fax 773-792-2129

www.switchcraft.com