



BrightEye™ 75

HD/SD Analog to Digital Video Converter and Analog Audio Embedder User Guide

ENSEMBLE

D E S I G N S

Revision 2.1 SW v1.0.7

This user guide provides detailed information for using the **BrightEye 75** HD/SD Analog to Digital Video Converter and Analog Audio Embedder with TBC.

The information is organized into the following sections:

- Product Overview
- Functional Description
- Applications
- Rear Connectors
- Operation
 - Front Panel Controls and Indicators
 - Using the BrightEye Control Application
- Warranty and Factory Service
- Specifications
- Glossary

PRODUCT OVERVIEW

BrightEye 75 converts standard definition analog component or composite video, or high definition analog component video to SDI with simultaneous conversion of two channels of audio and embedding. A TBC/Frame Sync is a standard feature and allows the BrightEye to work with any type of video input.

BrightEye 75 is versatile enough to handle applications from broadcasting to desktop video with sources such as VTRs and incoming satellite feeds.

Basic controls are accessed on the front panel. The BrightEye Control application provides access to video proc functions, input and output, and built-in audio mixer controls that are not available from the front panel.

FUNCTIONAL DESCRIPTION

As shown in the functional block diagram below, analog video is converted at 14 bits of resolution and digitally decoded to YCrCb components (601). The signal is then time base corrected and frame synchronized to the reference input. Proc amp adjustments are provided for the converted video.

The audio is converted to digital and then passes through the built-in 2-channel mixer with shuffle and level control.

The video and audio signals are joined in the embedder. This embedded signal passes through a serializer to an SDI output on the rear of the unit.

BrightEye 75 is powered by a 12 volt DC universal power supply. This power supply can accept an input voltage between 90 and 230 volts, at 50 or 60 Hertz. It uses a standard IEC line cord and can be used anywhere in the world. It is normal for the converter to be quite warm to the touch when operating.

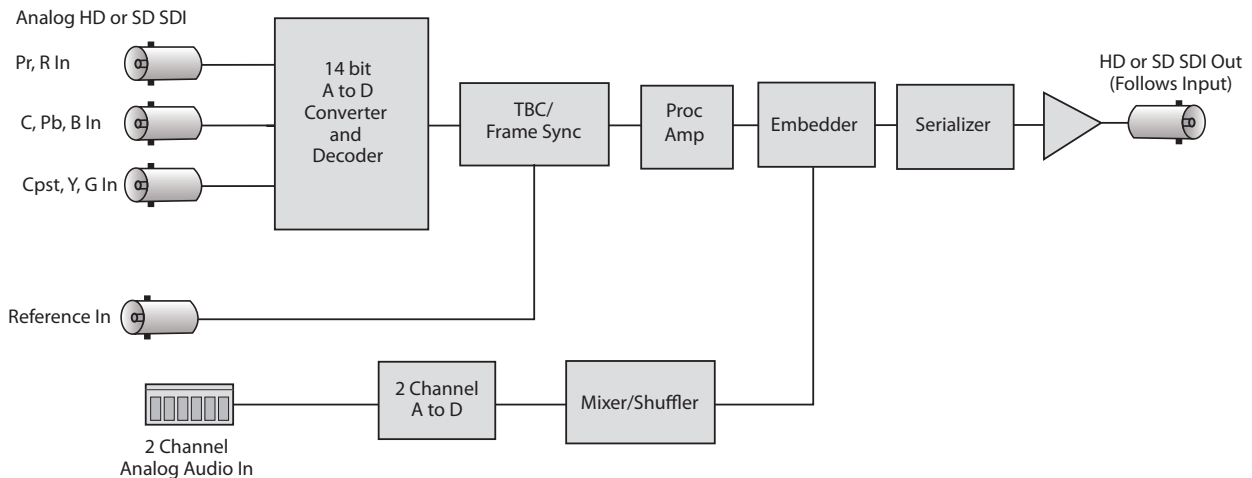

BrightEye 75 Functional Block Diagram, Portrait View

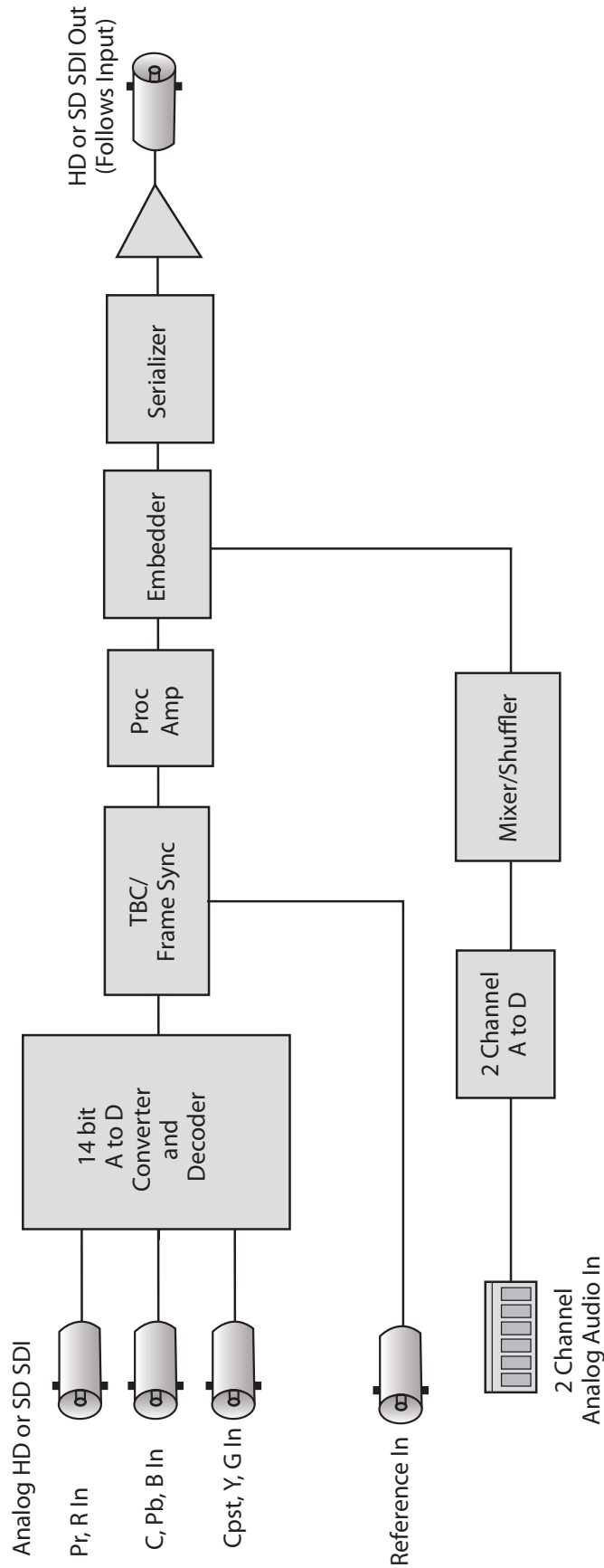

BrightEye 75 Functional Block Diagram, Landscape View

APPLICATIONS

The BrightEye 75 is well-suited to applications using HD Cameras or other devices with analog I/O. The built-in TBC/Frame Synchronizer allows you to feed asynchronous or noisy signals to the BrightEye 75. These are then digitized and time-base corrected by noise-tolerant tracking circuitry.

The example below shows a three-camera, live studio setup. Full bandwidth analog video from an HD camera is fed to a BrightEye 75 and converted to HD SDI digital video. The signal is time base corrected and frame synchronized to the reference input. The signal is then sent to a Production Switcher and out to live broadcast.

The analog audio from the cameras enters the BrightEye 75 two-channel A to D converter. Adjustments for audio mixing, audio levels, and channel shuffling can then be applied to the audio before it is embedded into the SDI output signal and fed to air.

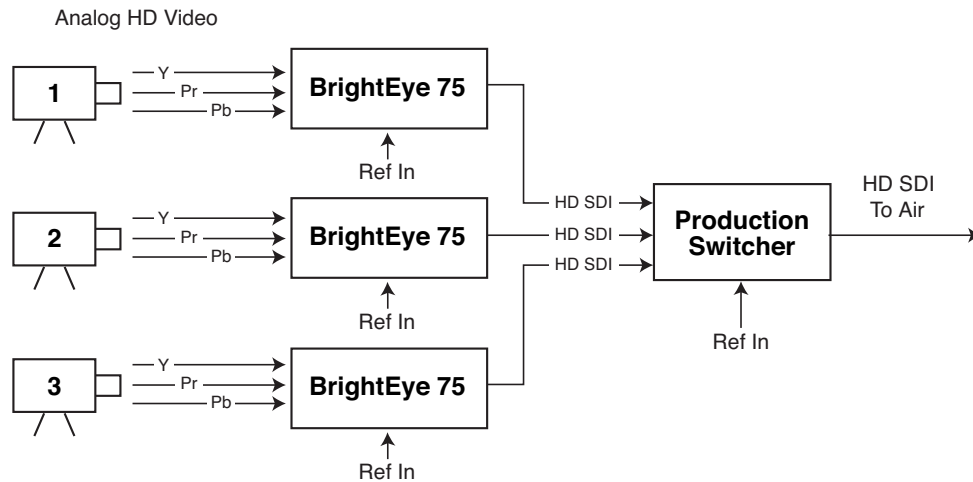

BrightEye 75 Signal Ingest Application for HD Signals

REAR CONNECTORS

All connections to the BrightEye 75 converter are made on the rear of the unit. Refer to the illustration below.

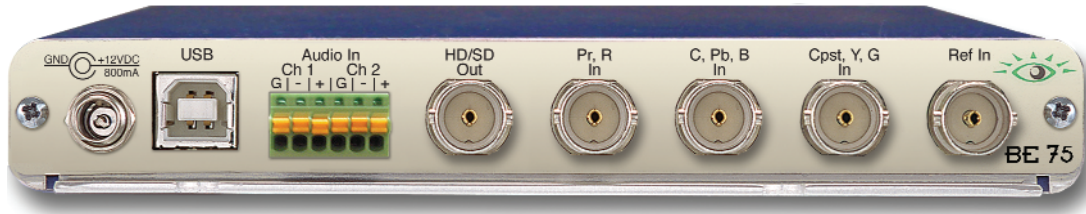

BrightEye 75 Rear Connectors

Power Connection

Connect a modular power supply to the 12 volt DC power input connection on the far left of the unit. Use the locking ring to secure it.

USB Connector

The USB connector is used to provide more comprehensive control, diagnostics, and upgrades to the unit from a PC or Mac. Use the BrightEye Control application included on CD-ROM to make adjustments as described in the **OPERATION** section of this user guide.

Audio In

This 6-pin Phoenix connector provides two channels of analog audio input. Wiring is done by inserting the connector provided with the unit. The pinouts are shown in the diagram below.

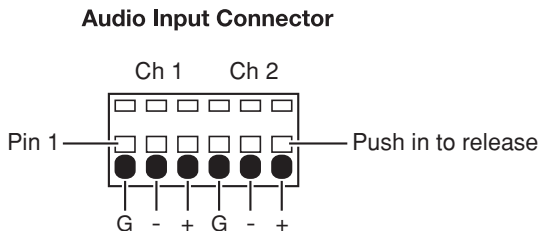

To connect audio to this connector, strip the audio wire to about 3/8" (8 mm). Solder tinning is not required. Push the wire into the opening at the bottom of the connector to seat the connection. This will snap the wire into place. To remove the wire, push in the pin above the connection with a small pointed tool. This will release the wire from the connector.

Balanced Analog Audio Connection – to connect the audio input to an audio XLR connector, connect the pins as follows:

- Attach Ground from Pin 1 of the Audio In to Pin 1 of the XLR.
- Attach the + (plus) signal from Pin 3 of the Audio In to Pin 2 of the XLR.
- Attach the – (minus) signal from Pin 2 of the Audio In to Pin 3 of the XLR.

Unbalanced Audio to a RCA Phono Connection – to connect the BrightEye 75 audio input to a consumer audio connector such as an RCA phono jack, connect the pins as follows:

- Attach Ground from Pin 1 of the Audio In to the shell, Shield or Ground of the RCA Phono jack.
- Attach the + (plus) signal from Pin 3 of the Audio In to the center pin of the RCA Phono jack.
- Attach the – (minus) signal from Pin 2 of the Audio In to the shell, Shield or Ground of the RCA Phono jack.

Input/Output BNCs

There are five rear BNC connectors used as inputs and outputs as follows:

HD/SD Out

This BNC outputs a timed SDI video signal with embedded audio.

Pr, R In

This BNC accepts the following signal formats:

- Beta or SMPTE – Pr (Y-R) input
- RGB – R input

C, Pb, B In

This BNC accepts the following signal formats:

- S-Video (composite) – C input
- Beta or SMPTE – Pb input
- RGB – B input

Cpst, Y, G In

This BNC accepts the following signal formats:

- Composite (Cpst) – analog composite input
- S-Video (composite) – Y input
- RGB – G input

Ref In

This BNC accepts an analog composite video signal which is used as the genlock and timing reference for the internal TBC/Frame Synchronizer. Typically the reference signal is Color Black or Color Bars fed from a master sync generator (such as the BrightEye 55).

OPERATION

Control and operation of the BrightEye 75 unit is performed from the front panel or remotely from a networked PC with the BrightEye Control application.

NOTE: *Some control settings are only available with BrightEye PC or Mac. These parameters cannot be monitored or controlled from the front panel.*

Front Panel Controls and Indicators

The front panel of the converter, shown below, provides status and control indicators for the module.



BrightEye 75 Front Panel

STATUS INDICATORS

The following status indicators are provided on the front panel:

In

Illuminates green when a valid analog video signal in the currently selected format is detected on the corresponding BNC connector.

Ref (Reference)

Illuminates green when a valid NTSC or PAL reference is detected on the rear panel **Ref In** BNC connector.

Source Select

The currently selected video input format illuminates green.

TBC

Illuminates green when the TBC is enabled.

Vid Gain

Illuminates green when gain is set to its nominal or unity setting, or red when set to other than unity.

Gain

Illuminates green when gain is set to its nominal or unity setting, or red when set to other than unity.

VU

Illuminates green when gain is set to unity, red when set to other than unity, or yellow when gain exceeds 0 VU (-20dBFS).

Pwr (Power)

Illuminates green when power is applied to the converter.

ADJUSTING PARAMETERS FROM THE FRONT PANEL

Use the **Mode**, **Right Arrow**, and **Left Arrow** buttons to select and adjust parameters from the front panel.

Pressing the **Mode** button activates the front panel for editing and tabs between each section of editable parameters.

Pressing the **Right Arrow** or **Left Arrow** advances the selection within a given section of parameters, or increases (Right Arrow) or decreases (Left Arrow) the value of a selected parameter.

NOTE: *The LED of an edited parameter will blink for 15 seconds, after which time its value is stored in memory. If power is interrupted before this 15 second timeout period has elapsed, the edited state will not be saved.*

The controls and their indicators are described below:

Source Select

Selects the video input source format from the following choices:

Cpst – NTSC or PAL Analog Composite Video

Y/C – S-Video Composite Video

RGB – Component Video in RGB format

SMPTE – Component Video in SMPTE format

Beta – Component Video in Beta format

Bars – Internal Color Bar Generator

TBC

This control turns the TBC/Frame Sync function on or off when an external reference is present on the **Ref In** BNC. Use the left arrow to turn it off; use the right arrow to turn it on. The TBC indicator illuminates green when on.

Vid Gain

This control adjusts the gain of the analog video signals of the converter. The right arrow increases the gain; the left arrow decreases it. The **Vid Gain** indicator illuminates green when the gain is set to its nominal or unity setting.

Setting **Vid Gain** to unity ensures correct analog output levels from an analog input source that is at proper level itself. The **Vid Gain** indicator illuminates red if the control is adjusted higher or lower than its nominal setting. To reset gain to its nominal setting (green) press both arrows simultaneously.

Audio

Output level and the status of audio channels 1 and 2 are indicated by the state the **VU** and **Gain** indicators:

VU

This indicator illuminates red when the audio level exceeds the headroom level set with the **Peak Indicator** control in BrightEye PC or Mac. Additionally, the **VU** indicator illuminates yellow when the output is above 0 VU, and illuminates green when the output is above -20 VU. When the output level is below -20 VU, the indicator does not illuminate.

Gain

This indicator Illuminates green when output gain is set to its nominal or unity value. It illuminates red when gain is set to other than unity.

USING THE BRIGHT EYE CONTROL APPLICATION

The BrightEye PC and BrightEye Mac applications included on CD-ROM are designed to allow you to configure and control the BrightEye 75 from a personal computer. Installation and instructions for using this software application are given in the PDF manual on disk.

If the BrightEye 75 is connected to a computer running this software, the following menus are available for controlling and monitoring the unit.

Input Menu

- **Input Pres** – indicates the status of the video input (**None**, **SD 525**, **SD 625**, **HD 525**, or **HD 625**).
- **Input Sel** – select the type of input signal to the unit from the pulldown as **Composite**, **Y/C**, **RGB**, **SMPTE**, **Beta**, or **Bars**.
- **Analog Setup** – set to **On** if setup is present on the analog input, or **Off** if no setup is present.
- **Ref Status** – indicates the status of a reference video presence (**No Reference** or **Ref Present**).

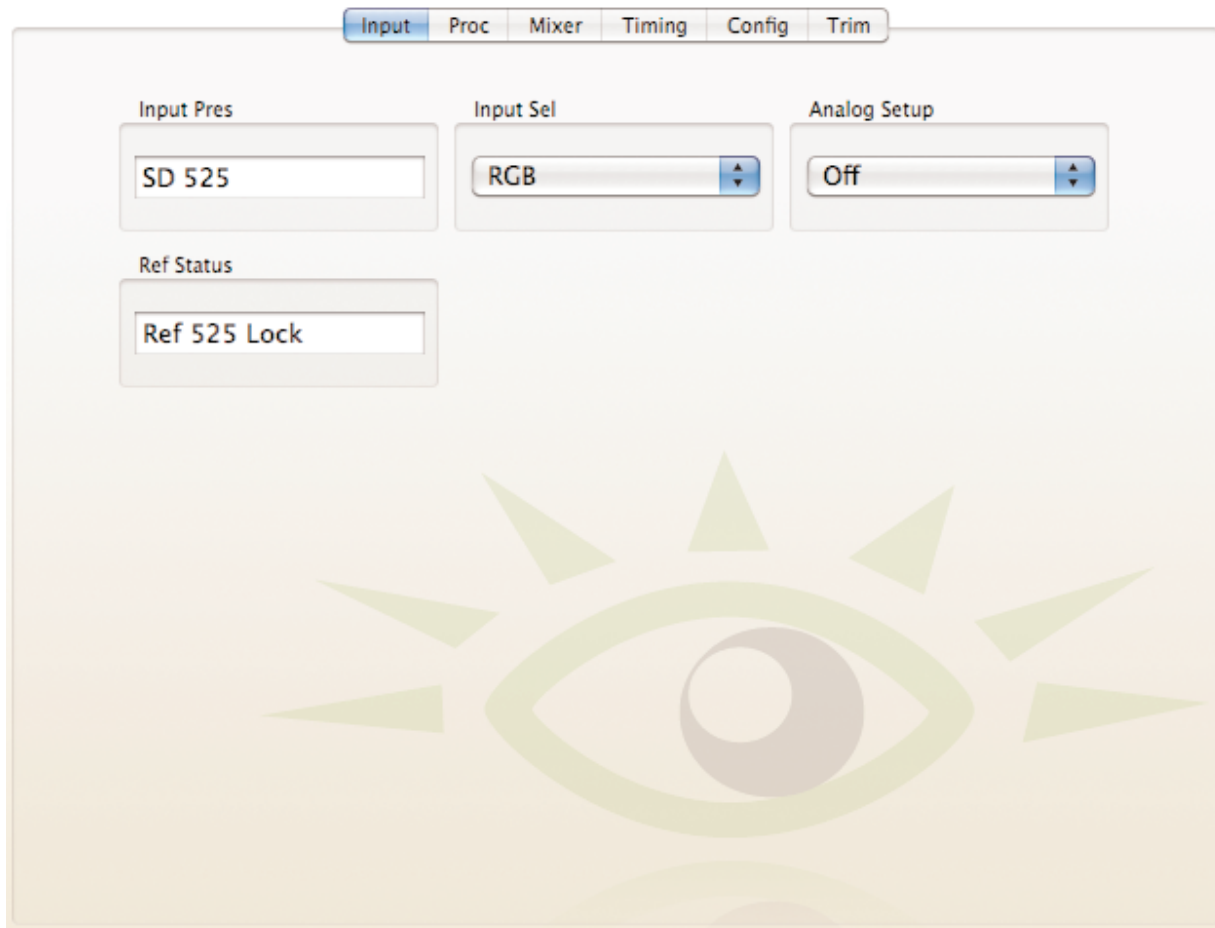

Proc Menu

Use the Proc Menu to adjust the parameters of the analog video input signal.

The **Proc** menu provides the following video adjustments:

- **Gain** – adjust the overall gain of the signal from 0 to 150%.
- **Chroma** – adjust the chroma gain of the signal from 0 to 150%.
- **Pedestal** – adjust the pedestal level of the signal +/- 5 IRE.
- **Hue** – adjust the hue of the signal +/- 180 degrees.

To set a value for any of these parameters, adjust the slider, click the right or left Arrow button, or type a value into the appropriate field.

To set a parameter to its nominal setting, click the **Default** button.



Mixer Menu

Use the Mixer Menu to adjust the parameters of the embedded audio input signal.

- **Output 1** – provides peak/VU status for output channel 1. The **Peak/VU** indicator illuminates red when the audio level exceeds the headroom level set with the **Peak Indicator** control in the **Config** menu. Additionally, the indicator illuminates yellow when the output level exceeds 0 VU, or illuminates green when the output is above -20 VU. When the output level is below -20 VU, the indicator does not illuminate.
- **Output 2** – provides peak/VU status output channel 2. The **Peak/VU** indicator illuminates red when the audio level exceeds the headroom level set with the **Peak Indicator** control in the **Config** menu. Additionally, the indicator illuminates yellow when the output level exceeds 0 VU, or illuminates green when the output is above -20 VU. When the output level is below -20 VU, the indicator does not illuminate.
- **Input Ch 1** – assign Input Channel 1 to the desired output bus or tie it to Channel 2. Set the input level using the slider or by entering a number in the **dB** field and pressing the **Enter** key on your PC.
- **Input Ch 2** – assign Input Channel 2 to the desired output bus or tie it to Channel 1. Set the input level using the slider or by entering a number in the **dB** field and pressing the **Enter** key on your PC.

Clicking **Tie** on either channel ties the two slider controls together so that their output levels can be adjusted in tandem.

Click the **Default** button to return to the default value.

Click the **Invert** button to invert the phase of the audio content.

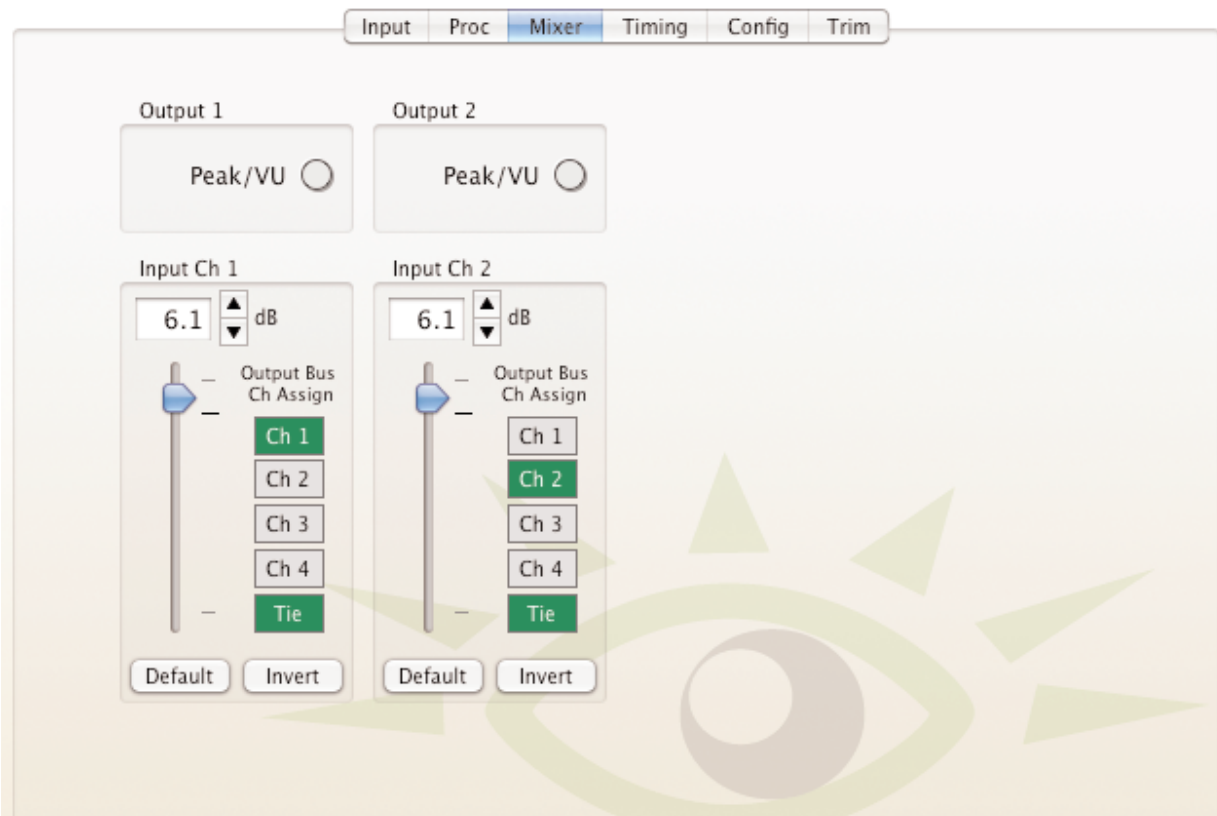

Timing Menu

Use the Timing Menu to set the parameters of the TBC and Frame Sync functions. The timing function operates in one of three modes:

1. When the **Frame Sync** control is turned **On** and a proper reference signal is connected to the **Ref In** BNC, the video output of the unit is synchronous and locked to the external reference. The output may be timed with respect to the Ref In using the timing controls. In this case, the unit will accept asynchronous video and time base errors will be corrected.
2. When the **Frame Sync** control is turned **On** and no reference signal is connected, the unit acts as a time base corrector only. The output is not synchronous to any reference, including the input. This mode allows a noisy input signal to be time base corrected for a clean, stable output.
3. When the **Frame Sync** control is turned **Off**, any reference signal to the **Ref In** BNC is ignored. The video input is synchronous to the video output when a nearly perfect, clean video input signal is present (no time base correction required).

The following timing control is available when the **Frame Sync** function is **On**:

- **Timing** – adjust the vertical and horizontal timing of the signal with respect to the reference input. Click the **Default** button to return to the default value.

Use the following control to enable the **Frame Sync** function:

- **Frame Sync** – set the **Frame Sync** function to **On** to genlock to the reference input to the module, or to **Off** for no Frame Sync.

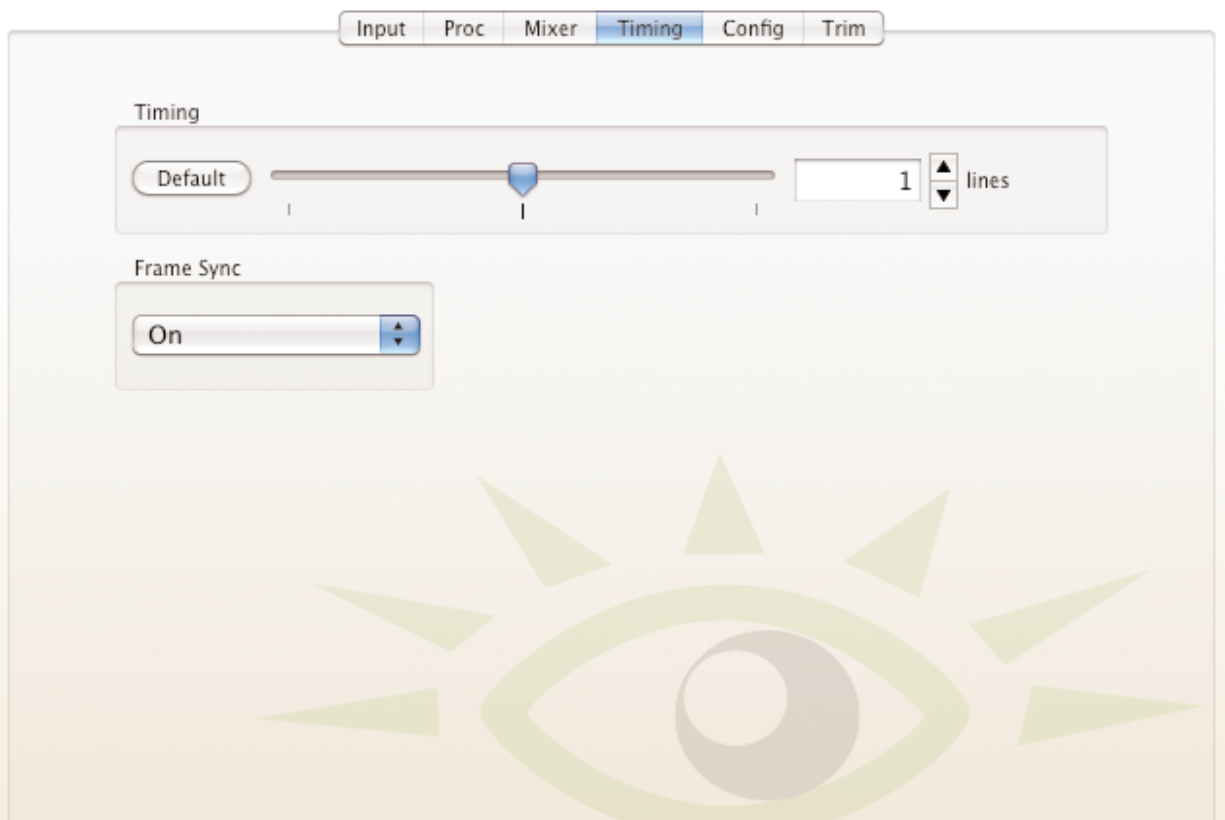

Config Menu

Use the **Config** menu to set the following output conditions for the output signal:

- **Signal Mute** – select the condition for muting the output signal to **No Muting**, **Mute On Noise**, or **Freeze on Noise**.
- **Analog Setup** – set to **On** if setup is present on the analog input, or **Off** if no setup is present.
- **V Blanking** – set the vertical blanking to **Narrow** (NTSC: lines 1-9, PAL: lines 1-6) or **Wide** (NTSC: lines 1-20, PAL: lines 1-22).
- **Comb Mode** – set the comb filtering to **Comb On** or **Comb Off**.
- **Peak Indicator** – selects the amount of headroom used in determining peak indication. Choose **Clipping**, **2 dB Headroom**, **4 dB Headroom**, **6 dB Headroom**, **8 dB Headroom**, or **10 dB Headroom**.
- **Dig Ref Level** – selects the digital reference output level. Choose **-20 dBFS** or **-18 dBFS**.
- **Anlg Ref Level** – selects the analog audio input level for embedding. Choose **-10 dBu** or **+4 dBu**.

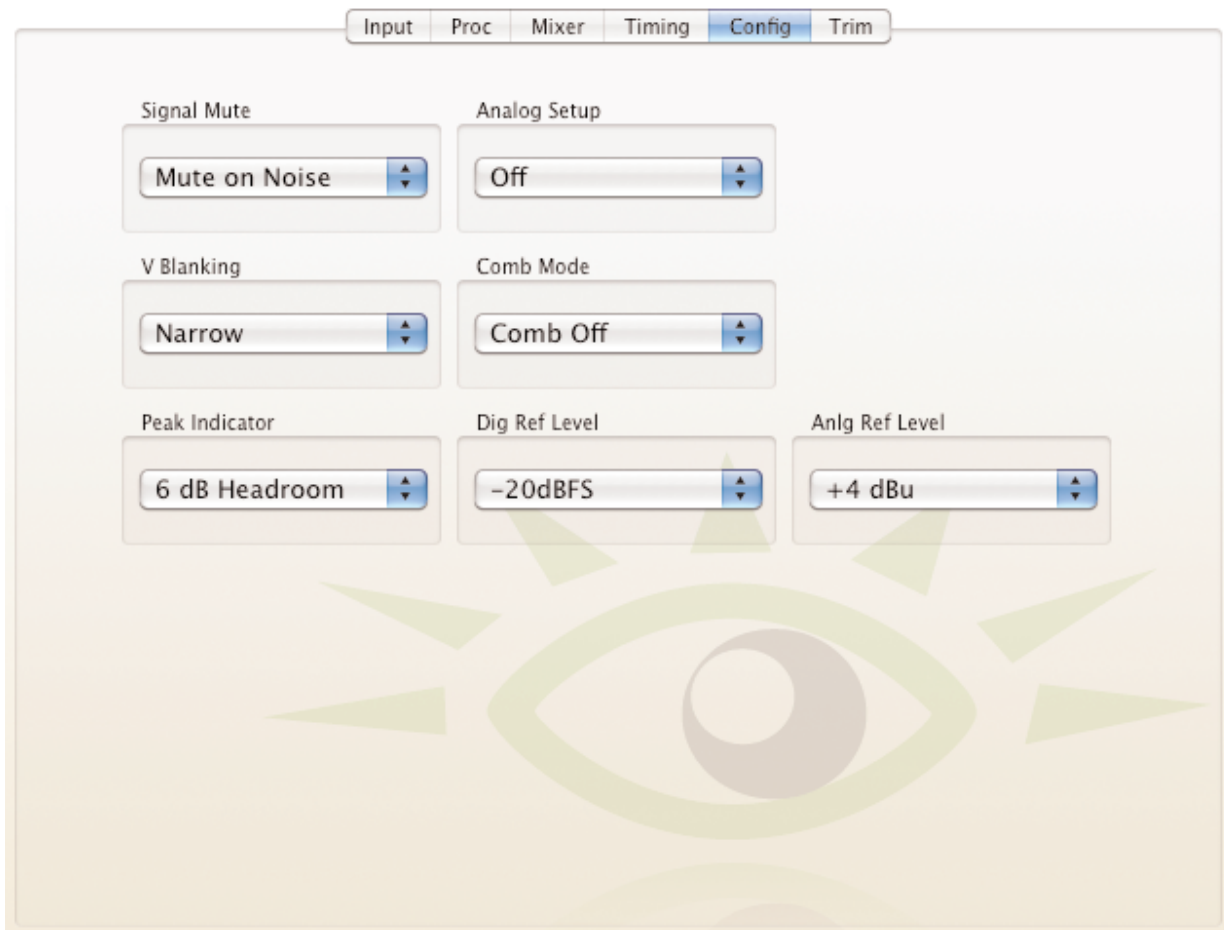

Trim Menu

The **Trim** menu provides an advanced level of adjustment to match your BE75 to a particular source if needed. Use the **Trim** menu to fine tune the color parameters of the output signal up or down, positive or negative. The values shown below are typical, though each BE75 may vary.

- When input is Cpst, adjust **Composite Trim** and **Saturation Trim** from -100 to 100.
- When input is Y/C, adjust **Composite Trim** and **Saturation Trim** from -100 to 100.
- When input is RGB, adjust **CAV Y/C Trim**, **CAV Cr/R Trim** and **CAV Cb/B Trim** from -100 to 100.
- When input is SMPTE, adjust **CAV Y/C Trim**, **CAV Cr/R Trim** and **CAV Cb/B Trim** from -100 to 100.
- When input is BETA, adjust **CAV Y/C Trim**, **CAV Cr/R Trim** and **CAV Cb/B Trim** from -100 to 100.

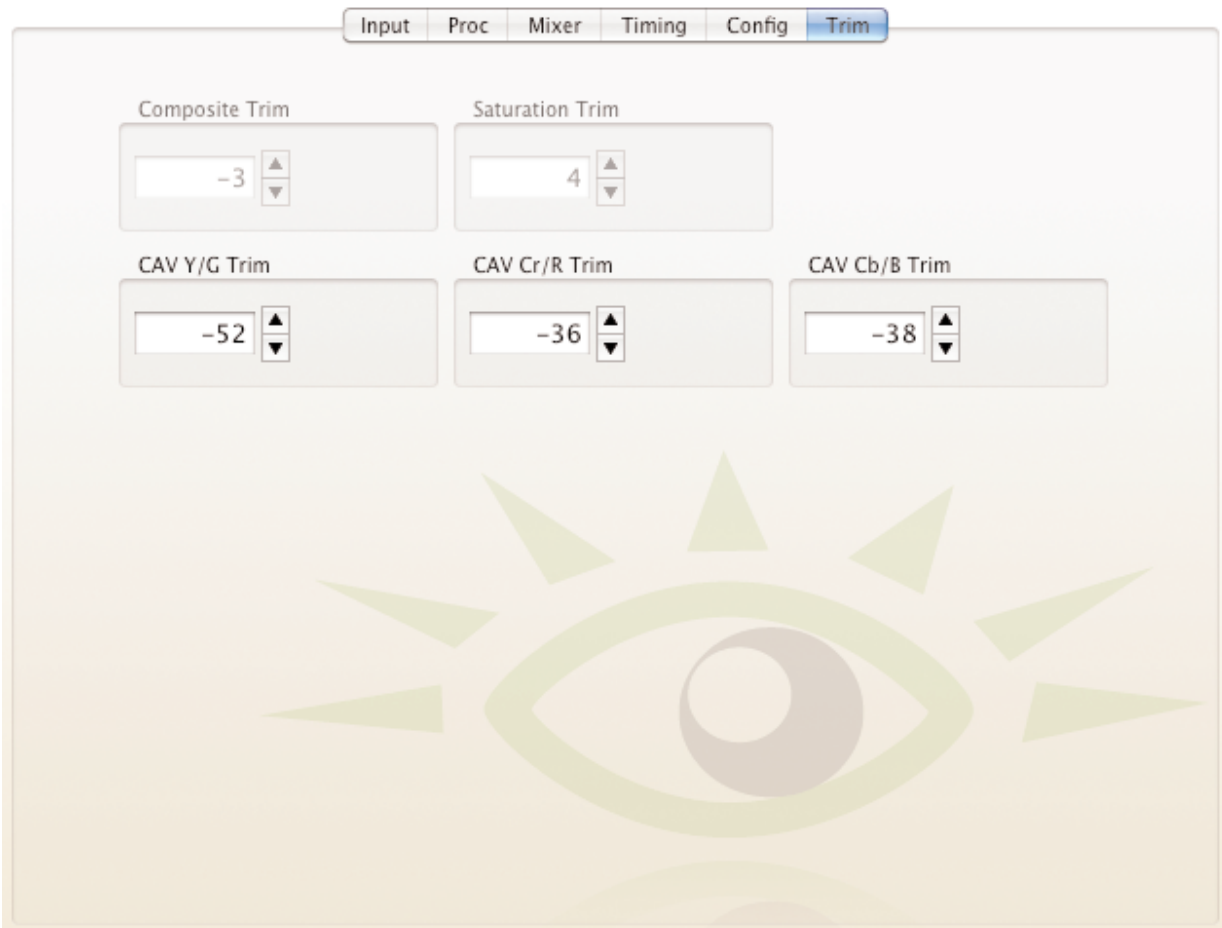

WARRANTY AND FACTORY SERVICE

Warranty

Ensemble Designs, Inc. warrants this product to be free from defect in material and workmanship for a period of 5 years from the date of delivery. During this 5 year warranty period, Ensemble Designs, Inc. will repair any defective units at Ensemble's expense if the unit should be determined to be defective after consultation with a factory technician.

This warranty is not transferable. Any implied warranties expire at the expiration date of this warranty.

This warranty does not cover a defect that has resulted from improper or unreasonable use or maintenance as determined by us. This warranty is void if there is any attempt to disassemble or adjust factory set presets without factory authorization.

Factory Service

If you require service (under warranty or not), please contact Ensemble Designs and ask for Customer Service before you return the unit. This will allow the service technician to provide any other suggestions for identifying the problem and recommend possible solutions.

You may also refer to the technical support section of the Ensemble web site for the latest information on your equipment at the URL below:

<http://www.ensembledesigns.com/support>

If you return equipment for repair, please get a Return Material Authorization Number (RMA) from the factory first.

Ship the product and a written description of the problem to:

Ensemble Designs, Inc.
Attention: Customer Service RMA #####
870 Gold Flat Rd.
Nevada City, CA 95959 USA
(530) 478-1830
Fax: (530) 478-1832
service@ensembledesigns.com
<http://www.ensembledesigns.com>

Be sure to put your RMA number on the outside of the box.

SPECIFICATIONS

Analog Video Input

Number	One
Signal Type	HD or SD: Y, Pr, Pb (SMPTE or Beta levels) HD or SD: Analog Component RGB (sync on green) Analog Composite PAL or NTSC Analog S-Video PAL or NTSC
Resolution	Digitized at 12 bits
Impedance	75 Ω
Return Loss	> 40 dB
Input DC	+/- 1 volt DC
Input Hum	< 100 mV

Analog Audio Inputs

Number	Two
Type	Balanced
Impedance	> 15K Ω
Max Input Level	24 dBu
CMRR	> 60 dB, 20 Hz to 10 KHz
Quantization	24 bits, 128x oversampled
Sample Rate	48 KHz
Reference Level	-10 dBu or + 4 dBu
Frequency Response	\pm 0.1 dB, 20 Hz to 20 KHz
Crosstalk	< 106 dB
Dynamic Range	> 106 dB

Serial Digital Output

Number	One
Type	Follows input standard HD Serial Digital 1.485 Gb/s SMPTE 274M, 292M or 296M or SD Serial Digital 270Mb/s SMPTE 259M-C
Impedance	75 Ω
Return Loss	> 15 dB
Max Cable Length	100 meters for HD 300 meters for SD (Belden 1694A)

Analog Video to SDI Performance

Bit Resolution	14-bit input quantization, 4x oversampling
Decoding	Fully adaptive comb filter
K Factors	> 1%
Signal to Noise	> 64 dB weighted
Freq Response	\pm 0.1 dB, 0 to 5.5 MHz in SD \pm 0.1 dB, 0 to 12 MHz; \pm 0.5 dB, 12 to 30 MHz in HD

HD Standards Supported

- 1080i (SMPTE 274M -4,5,6) 50, 59.94 or 60 Hz
- 720p (SMPTE 296M -1,2,3) 50, 59.94 or 60 Hz
- 1080p (SMPTE 274M -9,10,11) 23.98, 24, 25 Hz
- 1080sF (RP211 -14,15,16) 23.98, 24, 25 Hz

Embedded Output (In Serial Output)

- Group Assign One of four groups
- Channels Two
- Bit Depth 24 Bit

Reference Input

- Number One
- Signal Type 1 V p-p Composite Video, PAL or NTSC
- Impedance 75 Ω
- Return Loss > 40 dB

General Specifications

- Size 5.625" W x 0.8 " H x 5.5" D
(143 mm x 20 mm x 140 mm)
including connectors
- Weight 15 oz
- Power 12 volts, 6 watts
(100-230 VAC modular power supply not included)
- Temperature Range 0 to 40° C ambient
- Relative Humidity 0 to 95%, non-condensing

Due to ongoing product development, all specifications subject to change.

BRIGHTEYE POWER SUPPLY INFORMATION

Below is a list of power supplies and optional items that may have come with your BrightEye:

BEPS	BrightEye Individual Power Supply
BEPS-RP	Redundant Power Supply for Individual and Spider Power Supply
BEPS6	Spider Power Supply powers 6 single high BrightEyes or 3 double high BrightEyes
BERKMT	BrightEye Rack Mount (holds 3 to 6 BrightEyes) 1RU high, 6"/152.4 mm deep, 3 lbs/1.4 kg
BEBP	BrightEye Blank Panel (single high, for empty slots in Rack Mount)
BEBPD	BrightEye Blank Panel (double high, for empty slots in Rack Mount)
5082-I	1 Port AES 110 Ohm Adapter
BEAC	Analog Audio Breakout Cable with Pigtail End
PHX15	Breakout Adapter with Phoenix Terminals

GLOSSARY

This is a brief glossary of commonly used terms associated with this product.

AES/EBU

The digital audio standard defined as a joint effort of the Audio Engineering Society and the European Broadcast Union. AES/EBU or AES3 describes a serial bitstream that carries two audio channels, thus an AES stream is a stereo pair. The AES/EBU standard covers a wide range of sample rates and quantizations (bit depths.) In television systems, these will generally be 48 KHz and either 20 or 24 bits.

Bandwidth

Strictly speaking, this refers to the range of frequencies (i.e. the width of the band of frequency) used by a signal, or carried by a transmission channel. Generally, wider bandwidth will carry and reproduce a signal with greater fidelity and accuracy.

Beta

Sony Beta SP video tape machines use an analog component format that is similar to SMPTE, but differs in the amplitude of the color difference signals. It may also carry setup on the luminance channel.

Blanking

The Horizontal and Vertical blanking intervals of a television signal refer to the time periods between lines and between fields. No picture information is transmitted during these times, which are required in CRT displays to allow the electron beam to be repositioned for the start of the next line or field. They are also used to carry synchronizing pulses which are used in transmission and recovery of the image. Although some of these needs are disappearing, the intervals themselves are retained for compatibility purposes. They have turned out to be very useful for the transmission of additional content, such as teletext and embedded audio.

CAV

Component Analog Video. This is a convenient shorthand form, but it is subject to confusion. It is sometimes used to mean ONLY color difference component formats (SMPTE or Beta), and other times to include RGB format. In any case, a CAV signal will always require 3 connectors – either Y/R-Y/B-Y, or R/G/B.

Checkfield

A Checkfield signal is a special test signal that stresses particular aspects of serial digital transmission. The performance of the Phase Locked-Loops (PLLs) in an SDI receiver must be able to tolerate long runs of 0's and 1's. Under normal conditions, only very short runs of these are produced due to a scrambling algorithm that is used. The Checkfield, also referred to as the Pathological test signal, will “undo” the scrambling and cause extremely long runs to occur. This test signal is very useful for testing transmission paths.

Chroma

The color or chroma content of a signal, consisting of the hue and saturation of the image. See also Color Difference.

Component

In a component video system, the totality of the image is carried by three separate but related components. This method provides the best image fidelity with the fewest artifacts, but it requires three independent transmission paths (cables). The commonly used component formats are Luminance and Color Difference (Y/Pr/Pb), and RGB. It was far too unwieldy in the early days of color television to even consider component transmission.

Composite

Composite television dates back to the early days of color transmission. This scheme encodes the color difference information onto a color subcarrier. The instantaneous phase of the subcarrier is the color's hue, and the amplitude is the color's saturation or intensity. This subcarrier is then added onto the existing luminance video signal. This trick works because the subcarrier is set at a high enough frequency to leave spectrum for the luminance information. But it is not a seamless matter to pull the signal apart again at the destination in order to display it or process it. The resultant artifacts of dot crawl (also referred to as chroma crawl) are only the most obvious result. Composite television is the most commonly used format throughout the world, either as PAL or NTSC. It is also referred to as Encoded video.

Color Difference

Color Difference systems take advantage of the details of human vision. We have more acuity in our black and white vision than we do in color. This means that we need only the luminance information to be carried at full bandwidth, we can scrimp on the color channels. In order to do this, RGB information is converted to carry all of the luminance (Y is the black and white of the scene) in a single channel. The other two channels are used to carry the "color difference". Noted as B-Y and R-Y, these two signals describe how a particular pixel "differs" from being purely black and white. These channels typically have only half the bandwidth of the luminance.

Decibel (dB)

The decibel is a unit of measure used to express the ratio in the amplitude or power of two signals. A difference of 20 dB corresponds to a 10:1 ratio between two signals, 6 dB is approximately a 2:1 ratio. Decibels add while the ratios multiply, so 26 dB is a 20:1 ratio, and 14 dB is a 5:1 ratio. There are several special cases of the dB scale, where the reference is implied. Thus, dBm refers to power relative to 1 milliwatt, and dBu refers to voltage relative to .775V RMS. The original unit of measure was the Bel (10 times bigger), named after Alexander Graham Bell.

dBFS

In Digital Audio systems, the largest numerical value that can be represented is referred to as Full Scale. No values or audio levels greater than FS can be reproduced because they would be clipped. The nominal operating point (roughly corresponding to 0 VU) must be set below FS in order to have headroom for audio peaks. This operating point is described relative to FS, so a digital reference level of -20 dBFS has 20 dB of headroom before hitting the FS clipping point.

EDH

Error Detection and Handling is a method to verify proper reception of an SDI or HD-SDI signal at the destination. The originating device inserts a data packet in the vertical interval of the SDI signal and every line of the HD signal which contains a checksum of the entire video frame. This checksum is formed by adding up the numerical values of all of the samples in the frame, using a complex formula. At the destination this same formula is applied to the incoming video and the resulting value is compared to the one included in the transmission. If they match, then the content has all arrived with no errors. If they don't, then an error has occurred.

Embedded Audio

Digital Audio can be carried along in the same bitstream as an SDI or HD-SDI signal by taking advantage of the gaps in the transmission which correspond to the horizontal and vertical intervals of the television waveform. This technique can be very cost effective in transmission and routing, but can also add complexity to signal handling issues because the audio content can no longer be treated independently of the video.

Frame Sync

A Frame Synchronizer is used to synchronize the timing of a video signal to coincide with a timing reference (usually a color black signal that is distributed throughout a facility). The synchronizer accomplishes this by writing the incoming video into a frame buffer memory under the timing direction of the sync information contained in that video. Simultaneously the memory is being read back by a timing system that is genlocked to a house reference. As a result, the timing or alignment of the video frame can be adjusted so that the scan of the upper left corner of the image is happening simultaneously on all sources. This is a requirement for both analog and digital systems in order to perform video effects or switch glitch-free in a router. Frame synchronization can only be performed within a single television line standard. A synchronizer will not convert an NTSC signal to a PAL signal, it takes a standards converter to do that.

Frequency Response

A measurement of the accuracy of a system to carry or reproduce a range of signal frequencies. Similar to Bandwidth.

IEC

The International Electrotechnical Commission provides a wide range of worldwide standards. They have provided standardization of the AC power connection to products by means of an IEC line cord. The connection point uses three flat contact blades in a triangular arrangement, set in a rectangular connector. The IEC specification does not dictate line voltage or frequency. Therefore, the user must take care to verify that a device either has a universal input (capable of 90 to 230 volts, either 50 or 60 Hz), or that a line voltage switch, if present, is set correctly.

Interlace

Human vision can be fooled to see motion by presenting a series of images, each with a small change relative to the previous image. In order to eliminate the flicker, our eyes need to see more than 30 images per second. This is accomplished in television systems by dividing the lines that make up each video frame (which run at 25 or 30 frames per second) into two fields. All of the odd-numbered lines are transmitted in the first field, the even-numbered lines are in the second field. In this way, the repetition rate is 50 or 60 Hz, without using more bandwidth. This trick has worked well for years, but it introduces other temporal artifacts. Motion pictures use a slightly different technique to raise the repetition rate from the original 24 frames that make up each second of film—they just project each one twice.

IRE

Video level is measured on the IRE scale, where 0 IRE is black, and 100 IRE is full white. The actual voltages that these levels correspond to can vary between formats.

ITU-R 601

This is the principal standard for standard definition component digital video. It defines the luminance and color difference coding system that is also referred to as 4:2:2. The standard applies to both PAL and NTSC derived signals. They both will result in an image that contains 720 pixels horizontally, with 486 vertical pixels in NTSC, and 576 vertically in PAL. Both systems use a sample clock rate of 27 Mhz, and are serialized at 270 Mb/s.

Jitter

Serial digital signals (either video or audio) are subject to the effects of jitter. This refers to the instantaneous error that can occur from one bit to the next in the exact position each digital transition. Although the signal may be at the correct frequency on average, in the interim it varies. Some bits come slightly early, other come slightly late. The measurement of this jitter is given either as the amount of time uncertainty or as the fraction of a bit width. For 270 Mb/s video, the allowable jitter is 740 picoseconds, or 0.2 UI (Unit Interval – one bit width).

Luminance

The “black & white” content of the image. Human vision had more acuity in luminance, so television systems generally devote more bandwidth to the luminance content. In component systems, the luminance is referred to as Y.

Multimode

Multimode fibers have a larger diameter core (either 50 or 62.5 microns), and a correspondingly larger aperture. It is much easier to couple light energy into a multimode fiber, but internal reflections will cause multiple “modes” of the signal to propagate down the fiber. This will degrade the ability of the fiber to be used over long distances.

See also Singlemode.

NTSC

The color television encoding system used in North America was originally defined by the National Television Standards Committee. This American standard has also been adopted by Canada, Mexico, Japan, Korea, and Taiwan. (This standard is referred to disparagingly as Never Twice Same Color.)

Optical

An optical interface between two devices carries data by modulating a light source. This light source is typically a laser or laser diode (similar to an LED) which is turned on and off at the bitrate of the datastream. The light is carried from one device to another through a glass fiber. The fiber’s core acts as a waveguide or lightpipe to carry the light energy from one end to another. Optical transmission has two very significant advantages over metallic copper cables. Firstly, it does not require that the two endpoint devices have any electrical connection to each other. This can be very advantageous in large facilities where problems with ground loops appear. And secondly, and most importantly, an optical interface can carry a signal for many kilometers or miles without any degradation or loss in the recovered signal. Copper is barely useful at distances of just 1000 feet.

Oversampling

A technique to perform digital sampling at a multiple of the required sample rate. This has the advantage of raising the Nyquist Rate (the maximum frequency which can be reproduced by a given sample rate) much higher than the desired passband. this allows more easily realized anti-aliasing filters.

PAL

During the early days of color television in North America, European broadcasters developed a competing system called Phase Alternation by Line. This slightly more complex system is better able to withstand the differential gain and phase errors that appear in amplifiers and transmission systems. Engineers at the BBC claim that it stands for Perfection At Last.

Progressive

An image scanning technique which progresses through all of the lines in a frame in a single pass. Computer monitors all use progressive displays. This contrasts to the interlace technique common to television systems.

Return Loss

An idealized input or output circuit will exactly match its desired impedance (generally 75 ohms) as a purely resistive element, with no reactive (capacitive or inductive elements). In the real world we can only approach the ideal. So our real inputs and outputs will have some capacitance and inductance. This will create impedance matching errors, especially at higher frequencies. The Return Loss of an input or output measures how much energy is returned (reflected back due to the impedance mismatch). For digital circuits, a return loss of 15 dB is typical. This means that the energy returned is 15 dB less than the original signal. In analog circuits, a 40 dB figure is expected.

RGB

RGB systems carry the totality of the picture information as independent Red, Green, and Blue signals. Television is an additive color system, where all three components add to produce white. Because the luminance (or detail) information is carried partially in each of the RGB channels, all three must be carried at full bandwidth in order to faithfully reproduce an image.

ScH Phase

Used in composite systems, ScH Phase measures the relative phase between the leading edge of sync on line 1 of field 1 and a continuous subcarrier sine wave. Due to the arithmetic details of both PAL and NTSC, this relationship is not the same at the beginning of each frame. In PAL, the pattern repeats every 4 frames (8 fields) which is also known as the Bruch Blanking sequence. In NTSC, the repeat is every 2 frames (4 fields). This creates enormous headaches in editing systems and the system timing of analog composite facilities.

SDI

Serial Digital Interface. This term refers to inputs and outputs of devices that support serial digital component video. This generally means standard definition at 270 Mb/s. The use of “HD-SDI” is beginning to appear to indicate High Definition Serial Digital video at 1.485 Gb/s.

SMPTE

The Society of Motion Picture and Television Engineers is a professional organization which has done tremendous work in setting standards for both the film and television industries. The term “SMPTE” is also shorthand for one particular component video format - luminance and color difference.

Singlemode

A Singlemode (or monomode) optical fiber carries an optical signal on a very small diameter (9 micron) core surrounded with cladding. The small diameter means that no internally reflected lightwaves will be propagated. Thus only the original “mode” of the signal passes down the fiber. A singlemode fiber used in an optical SDI system can carry a signal for up to 20 kilometers. Singlemode fibers require particular care in their installation due to the extremely small optical aperture that they present at splice and connection points.

See also Multimode.

TBC

A Time Base Corrector is a system to reduce the Time Base Error in a signal to acceptable levels. It accomplishes this by using a FIFO (First In, First Out) memory. The incoming video is written into the memory using its own jittery timing. This operation is closely associated with the actual digitization of the analog signal because the varying position of the sync timing must be mimicked by the sampling function of the analog to digital converter. A second timing system, genlocked to a stable reference, is used to read the video back out of the memory. The memory acts as a dynamically adjusting delay to smooth out the imperfections in the original signal's timing. Very often a TBC will also function as a Frame Synchronizer.

See also: Frame Sync.

Time Base Error

Time base error is present when there is excessive jitter or uncertainty in the line to line output timing of a video signal. This is commonly associated with playback from video tape recorders, and is particularly severe with consumer type heterodyne systems like VHS. Time base error will render a signal unusable for broadcast or editing purposes.

Tri Level Sync

An analog sync reference signal that is used in High Definition systems. Tri Level Sync is constructed with three signal levels, the sync pulses extend above and below a mid-level average voltage (the blanking level). Unlike conventional analog sync which is bi-level, the proper 50% pickoff point is already identified in Tri Level Sync. This contributes to lower jitter in digital systems.

YUV

Strictly speaking, YUV does not apply to component video. The letters refer to the Luminance (Y), and the U and V encoding axes using in the PAL composite system. Since the U axis is very close to the B-Y axis, and the V axis is very close to the R-Y axis, YUV is often used as a sort of shorthand for the more long-winded "Y/R-Y/B-Y".

Y/Cr/Cb

In digital component video, the luminance component is Y, and the two color difference signals are Cr (R-Y) and Cb (B-Y).

Y/Pr/Pb

In analog component video, the image is carried in three components. The luminance is Y, the R-Y color difference signal is Pr, and the B-Y color difference signal is Pb.